

## Cool Compact Blast Chiller / Blast Freezer

### Vintos / Vintos+

4x GN 1/1 | 8x GN 1/1 | 10x GN 1/1 | 13x GN 1/1



<b>TABLE OF CONTENTS</b>		<b>Page</b>
<b>1.</b>	<b>Preliminary remark</b>	4
<b>2</b>	<b>Intended use</b>	4
<b>3.</b>	<b>General information</b>	4
<b>4.</b>	<b>Safety regulations</b>	5
<b>5.</b>	<b>Technical features</b>	5-6
<b>6.</b>	<b>Installation</b>	6-9
6.1	Transport and handling	6
6.2	Unpacking and installing	6-7
6.3	Electrical connection	7-8
6.4	Connection of an external unit	8-9
6.4.1	Setting up	9
6.4.2	Electrical connection	9
6.4.3	Connection to refrigerant line	9
6.5	Instructions for the installing technician	9
<b>7.</b>	<b>Control</b>	10-51
7.1	Overview: Basic functions Vintos	10
7.2	Overview: Basic functions Vintos+	11
7.3	Initial start-up of the controller	12
7.4	Blast chilling cycle – Vintos and Vintos+	13-15
7.5	Blast freezing cycle – Vintos and Vintos+	16-18
7.6	Combined cycle – Vintos+	19-21
7.7	Slow speed cooking cycle – Vintos+	22-24
7.8	Thaw cycle – Vintos+	25-27
7.9	Prove cycle – Vintos+	27-29
7.10	Storage cycle – Vintos+	30-31
7.11	Defrost cycle – Vintos and Vintos+	32
7.12	Sterilization cycle – Vintos+	33
7.13	Smart level control cycle – Vintos and Vintos+	34-36
7.14	Manual cycle – Vintos and Vintos+	37-39
7.15	Duplicate programmes / create own programmes – Vintos and Vintos+	39-42
7.16	Edit own programmes – Vintos and Vintos+	42-43
7.17	Move programmes in the product selection	44
7.18	Delete programmes in the product selection	45
7.19	Basic settings of the controller	46-47
7.20	Alarm messages	48
7.21	View and change parameter list	49
7.22	View and change relay	50

<b>TABLE OF CONTENTS</b>		<b>Page</b>
7.23	HACCP data export via USB stick	51-53
<b>8.</b>	<b>Maintenance</b>	<b>54-55</b>
8.1	Safety	54
8.2	Cleaning	54
8.3	Care	54
8.4	Extraordinary maintenance	55
<b>9.</b>	<b>Warranty and customer service</b>	<b>55</b>
<b>10.</b>	<b>Disposal and recycling</b>	<b>55</b>
<b>11.</b>	<b>Wiring diagrams</b>	<b>56-61</b>
<b>12.</b>	<b>EU – Declaration of Conformity</b>	<b>64</b>

## 1. PRELIMINARY REMARK

Congratulations on the purchase of your new Cool Compact blast chiller / blast freezer. All our appliances are subject to constant quality control and are designed for their use in commercial kitchens. Before using the appliance, please read the user manual carefully and pay particular attention to adhering to all safety precautions to ensure the highest performance capabilities and maximum safety when using the appliance.

The purpose of the user manual is to provide information on the following:

- general information
- safety regulations
- technical features
- installation
- use
- maintenance
- warranty and customer service
- disposal and recycling
- Declaration of Conformity

## 2. INTENDED USE

The blast chillers and blast freezers are used to lower the temperature of food products rapidly in order to avoid the proliferation of bacteria as well as to preserving the appearance, texture, aroma and flavor of the food products.

These units are used in two specific ways:

- Blast chilling to reduce the temperature of food products from +65°C to +3°C in 90 minutes
- Blast freezing to reduce the temperature of food products from +65°C to -18°C in 240 minutes

When using the blast chiller, depending on the food product, the most appropriate cooling cycle can be set.

Once a cycle is complete, the appliance switches into a storage mode. Please note that blast chillers / blast freezers can only preserve and store food for up to 36 hours.

## 3. GENERAL INFORMATION

- The appliance is to be used exclusively for the blast chilling / blast freezing of food.
- After unpacking, make sure that the appliance is not damaged. Otherwise, notify the dealer or installation technician immediately.
- Before starting the setup and installation, make sure that the power and supply voltage data on the rating plate label correspond to the data on-site. The rating plate label is located on the switch box behind the cover of the machine compartment and on the back of the user manual.
- In case of malfunctions, switch off the unit immediately.

The blast chillers / blast freezers may only be installed, commissioned and serviced by qualified refrigeration technicians or by personnel approved by the manufacturer. For a safe installation, use and maintenance of the blast chillers, please read the instructions in this user manual carefully and keep the instructions in an easily accessible place for reference by the user.

## 4. SAFETY REGULATIONS

In designing and manufacturing the blast chillers / blast freezers, emphasis has always been placed on maintaining the safety and integrity of the user.

- To prevent any accidental contact with live parts, guards with metal covers have been fitted. These guards may only be removed with the aid of tools by qualified personnel.
- To prevent any accidental contact with moving parts, the fan blades on the condenser and in the evaporator housing are covered with protective grilles.
- The electrical equipment complies with the EN 60335-1:2020-08 standard, among others.

As with any electrical appliance, the outlined safety regulations must be adhered to in order to avoid dangerous situations during installation and use.

- Disconnect the appliance from the power grid before carrying out any maintenance work.
- Do not operate with wet hands or feet.
- For general maintenance, do not remove or tamper with safety and protective devices and covers.
- Do not insert any kitchen utensils or kitchen tools into the protective covers for electrical or mechanical parts.
- Use appropriate and compatible tools for maintenance.
- When not in use, switch off the appliance and disconnect from the power grid.

Any failure to adhere to these rules may compromise the safety of the appliance and the user. The manufacturer takes no responsibility in the event of any modifications to the original mode of operation of the appliance due to the failure of following instructions or due to modifications or any additional installations of any devices.

## 5. TECHNICAL FEATURES

To identify the technical characteristics of the blast chiller, it is recommended to refer to the information on the rating plate label, which is located on the back of the user manual. The rating plate label is also located on the switch box behind the blast chiller's machine compartment panel and is used to:

- Identify the product by a customer service representative by the model type as well as the article and serial number.
- Provide information on the electrical power and voltage that is required to supply the machine.
- Provide information on the refrigerant type and quantity.

<b>TYP: SCHNELLKÜHLER / SCHOCKFROSTER</b>	
<b>Type: BLAST CHILLER / BLASTFREEZING</b>	
Modell / Model:	SKFZKQ0411D
Serien Nr. / Serial Nr.:	CC 201922083
Anschlusswert / Absorbed power:	0,8KW-50Hz-10A-230V
Kältemittel / Refrigerant fluid:	
Kapazität / Capacity:	4 x GN1/1
Nutzvolumen / Useful capacity:	
Kälteleistung / Refrigeration power:	420W-35°C VT / 1300W-10°C VT
Heizleistung / Heating power:	-
Max. Betriebsdruck / Max. pressure:	26 bar
Temp. Bereich / Temperature range:	-35°C bis +80°C
<b>COOL COMPACT, D-72415 Grosselfingen</b>	
Dokumentationsbevollmächtigter:	
Cool Compact Kühlgeräte GmbH	
Werner Pyka	
Balinger Straße 23	
D-72415 Grosselfingen	
Made in GERMANY	



The manufacturer rejects all responsibility in the event of improper use of the product. The manufacturer also reserves the right to make any modifications to its products that deems to be necessary or useful, without affecting the basic characteristics.

## 6. INSTALLATION

The installation, commissioning and maintenance of the blast chillers is only to be carried out by refrigeration technicians and / or technically qualified personnel or personnel approved by the manufacturer.

### 6.1. TRANSPORT AND HANDLING

For the correct transport and subsequent handling of the blast chillers, the following instructions should be followed:

- To avoid any damage to objects and persons, use appropriate means of transport and equipment for transporting the unit.
- For the use of appropriate means of transport, check the weight of the blast chiller.
- Caution: NEVER turn the appliance upside down or lay it on its side when transporting. Doing so could damage the unit and affect the functioning of the refrigeration circuit.

### 6.2. UNPACKING AND INSTALLING

Before installing, unpack the unit carefully.

- Move the still packed blast chiller near the installation site using a lift truck.
- Cut the straps and pull the cardboard packaging upwards. To avoid any damage to the appliance, do not use knives or any similar devices.
- Remove the blast chiller from the wooden pallet and place it in its final position.
- Fit the enclosed retaining rails for the condensate tray and insert the enclosed condensate tray. (See the assembly instructions for the condensate tray)

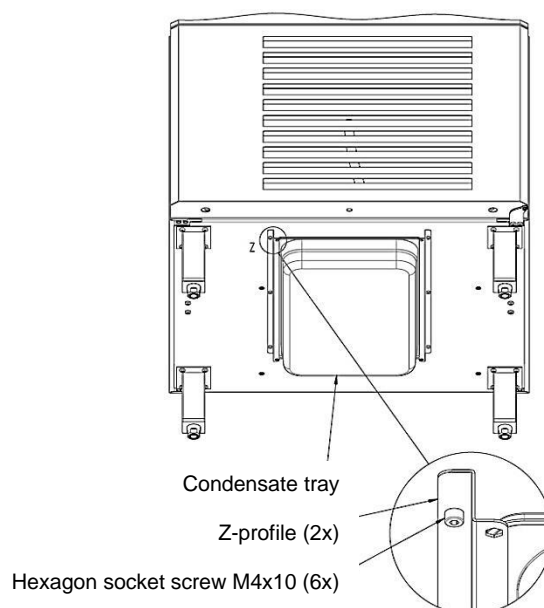

- Peel off the protective PVC film from all sides.
- Remove the plastic protection from the core temperature probe.
- Place the appliance horizontally in a well-ventilated location.
- Avoid locations directly next to a heat source or in direct sunlight.
- The location for installation must be well ventilated and low in dust.
- The air humidity should not exceed 70%.
- Any unevenness of the floor must be levelled out by the builder.
- The intake and exhaust area of the machine compartment (ventilation slots) must be kept clear to ensure a good ventilation.
- The surrounding temperature should be between +16°C and +32°C.
- A minimum clearance of 50 mm must be maintained on all sides to ensure a proper air circulation.
- The various packaging elements must be disposed of appropriately in accordance with the regulations that are in force in the country where the unit is used. In any case, the environment is not to be contaminated with any parts of the packaging material.



### 6.3. ELECTRICAL CONNECTION

The unit is supplied with a plug for connection to a power supply line.  
The unit must be connected by qualified personnel.

The manufacturer rejects all liability in the event of a connection by the user or by unqualified personnel.

- Make sure the electrical cable is intact and have it replaced by qualified personnel if it is damaged.
- The electrical supply line must be compatible to the power rating of the appliance (refer to the rating plate label).
- An all-pole power switch must be installed in the electrical supply line, which interrupts all contacts including the neutral conductor. This switch must have a distance of at least 3 mm between the open contacts and must be coupled with an appropriate overcurrent release or with a fuse. The dimensioning or setting must correspond to the power ratings indicated on the rating plate label.
- The main switch must be accessible near the unit and may only be used for one unit at a time.
- The earth wire existing on-site must be connected to the corresponding earth terminals of the unit.
- No adapters, multiple sockets, extension cables or cables with non-approved cross-sections may be used.
- The local standards must be adhered to.
- For details on the electrical operation, refer to the relevant wiring diagram in the operating instructions or in the switch box of the unit.
- The connection cable must not be pulled or crushed during normal operation or maintenance of the unit.

#### 6.4. CONNECTION OF AN EXTERNAL UNIT

The connection between two units must be made according to the following instructions.

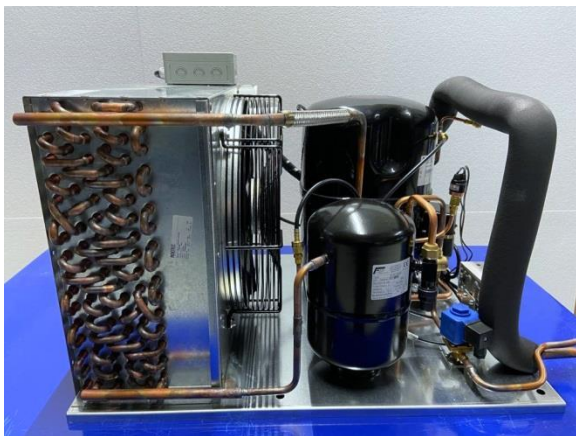

Refrigeration unit



Blast Chiller/ Blast Freezer



### 6.4.1. SETTING UP

After unpacking the condensing unit, follow the instructions for a proper installation:

- Set up the unit straight and on a solid surface.
- The refrigeration unit is suitable for an indoor and outdoor installation.
- For an outdoor installation, appropriate weatherproof housing must be provided.
- A suitable weatherproof housing can also be found in our accessories pricelist.
- The distance between the condensing unit and the blast chiller should be as close as possible.
- Do not install in direct sunlight or close to heat sources.
- A minimum clearance of 500 mm must be maintained on the air intake side and a minimum clearance of 1500 mm on the air exhaust side.
- The refrigerant lines should be installed with a downward slope to the refrigeration unit.
- Appropriate oil recirculation must be provided in riser lines.
- **The units are delivered without any refrigerant charge.**

### 6.4.2. ELECTRICAL CONNECTION

Connect the blast chiller to the switch panel in the condensing unit via 2 electrical cables (the minimum cross-section of which is specified in the technical data sheet) according to the specifications in the wiring diagram. When connecting the condensing unit to the switch panel, adhere to the wire and terminal numbers.

### 6.4.3. CONNECTION TO REFRIGERANT LINE

- Connect the liquid line of the condensing unit to the liquid line of the blast chiller.
- If the refrigeration unit is installed at a higher level than the blast chiller, the pipes must be equipped with appropriate siphons.
- Connect the suction line of the condensing unit to the suction line of the blast chiller.
- Open all shut-off valves of the system and evacuate the entire refrigeration circuit and check for leaks. Fill the refrigeration system with R452A.

Note the following when connecting the two units:

- Avoid reductions.
- Reduce possible bends to a minimum.
- Fit and attach the pipe in a suitable way.
- Provide the suction pipe with a suitable insulation.

### 6.5. INSTRUCTIONS FOR THE INSTALLING TECHNICIAN

After the blast chiller has been installed and connected, the technical personnel must check that the installation has been carried out correctly.

- Check the correct operation of the electrical connection.
- Before commissioning, the unit should be cleaned (see chapter 8.2).
- Insert accessories, such as support rails, grids, etc. at the appropriate height, as required.
- Make sure that the power consumption is according to the standard.
- Make sure that the gas pressures of the cooling system are correct.
- Run at least one complete cooling cycle to ensure that all parts of the unit are functioning properly.

## 7. CONTROL

### 7.1 OVERVIEW: BASIC FUNCTIONS VINTOS

Start screen chill



Start screen freeze

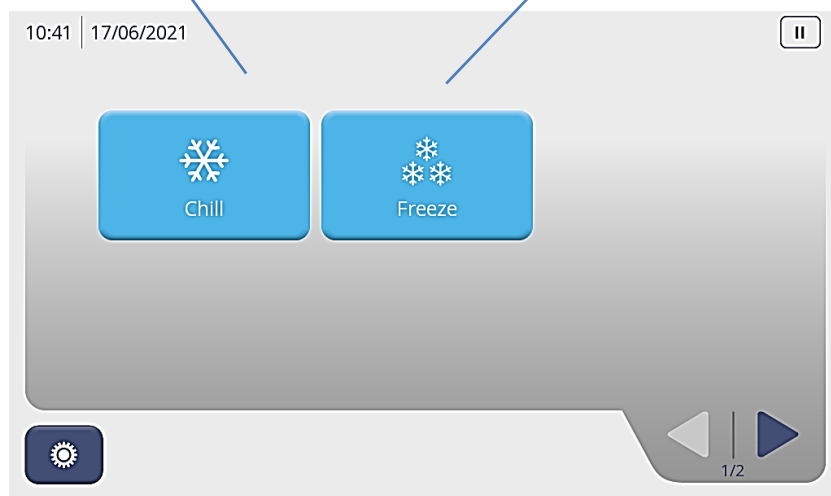

Start screen controller



Start screen basic settings

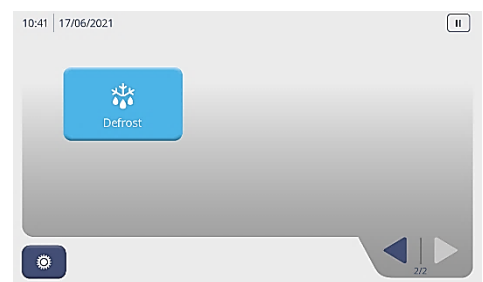

Page 2 start screen controller

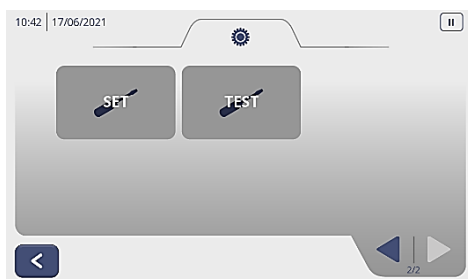

Page 2 basic settings

## 7.2 OVERVIEW: BASIC FUNCTIONS VINTOS+



### 7.3 INITIAL START-UP OF THE CONTROLLER

Check the following before initiating:

- The plug and socket must correspond to the power ratings on the rating plate label.
- The fuses in the fuse box must correspond to the rating specifications on the rating plate label.
- Only once points 1 and 2 have been checked you can insert the plug into the socket.
- The start screen now appears on the display.

#### Start screen



After pressing the menu key, the first page of the controller menu appears on the display

#### Page 1 controller menu

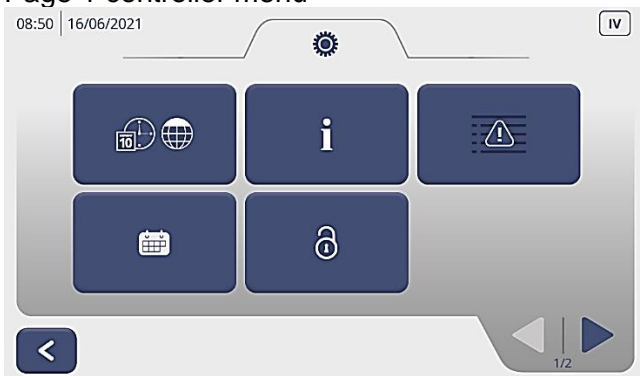

The upper left key allows access to the basic settings of the controller, such as date, language, etc.

#### Basic settings

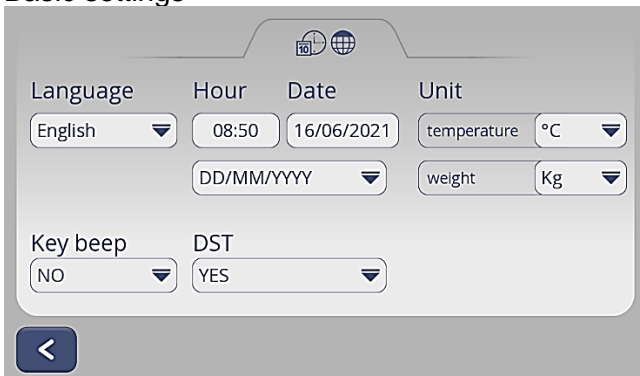

Check all factory settings, according to your country and time zone. Correct, if necessary.

If all data is set correctly, save the entered values with the arrow key and return to page 1 of the controller menu.

Press again to return to the start screen.

## 7.4 BLAST CHILLING CYCLE – VINTOS and VINTOS+

### Start screen

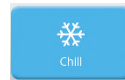

Press "chill" key

### Pop-up: preparing machine: cooling?

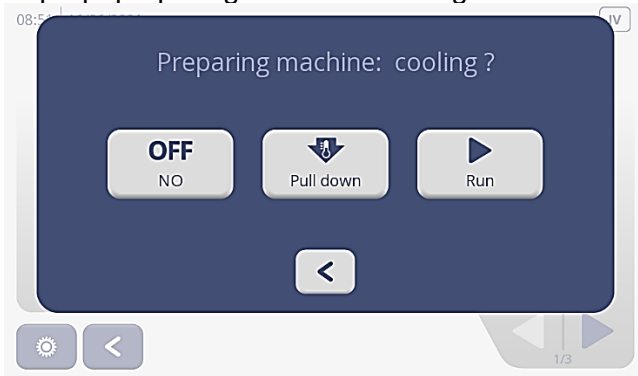

#### Explanation of key commands:

"OFF/No" key  
Press to return to the start screen



"Pull down" key  
Unit pre-cools to -15°C



"Run" key  
Unit immediately starts the blast chilling cycle



"Pull down" key  
Press and the unit starts

### Pop-up: preparing machine: cooling

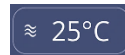

The display indicates the air temperature. Once the setpoint of -15°C is reached, a pop-up "unit pre-cooled" appears.



The "run" key takes you to a product selection menu with preset recipes for blast chilling various products as well as, on the second page, to the manual function and to the smart level control function.

### Product selection



Use the arrow key on the bottom right to scroll through the product selection menu and select the desired product to be chilled by pressing the corresponding key.

### Pop-up: HACCP



On this pop-up mask, enter the employee (author), the product and the weight of the product to be chilled.

Press the "OK" key.

Place the product to be chilled inside the unit and place the core probe in the product.

Close the door.

### Cycle interface: chill

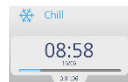
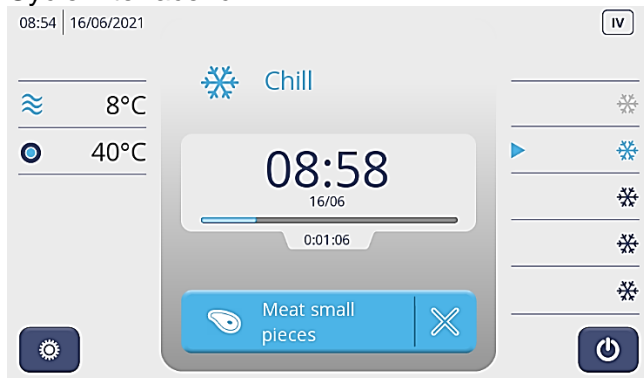

On the display the calculated end time appears in large digits.

Below, in small digits, the date of the cycle is displayed.

Depending on the progress and core temperature, the time may change during the cycle.

The scale shows the time progress of the process.

The elapsed time is displayed below.

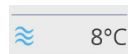

Display of the air temperature



The controller detects automatically if the core probe is inserted and displays this after a running time of 5 min. If the core probe is not inserted and detected, the unit runs automatically in the time programme cycle.

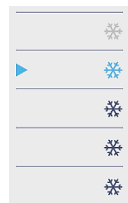

On the right-hand side, the individual steps of the cycle are displayed. You can recognise the current step by the light blue colour.

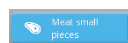

You can access the set cycle steps via the blue product button.

### Set cycle steps

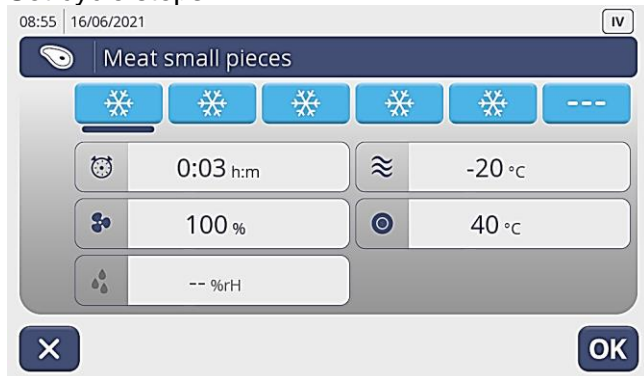





The blue line below the snowflake indicates which step of the cycle the controller is in.

You can use the snowflakes to select which step of the cycle you want to view and / or change / adjust.



In each of these cycle steps, the following individual changes can be made for the current cycle.

-  time
-  fan speed
-  air temperature
-  core temperature

### Pop-up: air setpoint



By pressing the air setpoint key for example, the corresponding window pops up and you can enter the desired value.

For negative (-) values, always enter the digit first and then the negative sign.

 Confirm with OK. The display jumps back to the cycle steps interface.

### Window: cycle steps

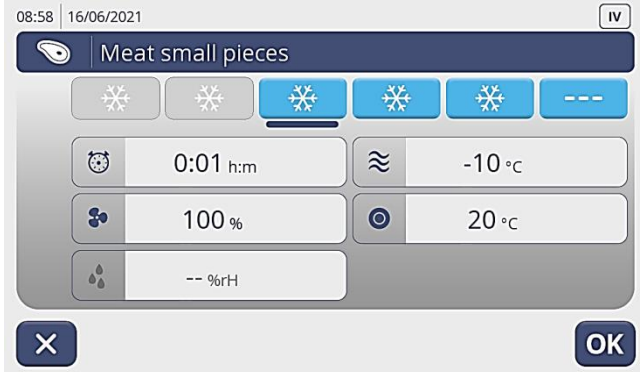

If all entries are correct, confirm with the OK key.

The display jumps back to the "chill" cycle interface.

### Cycle interface: chill



At the end of the cycle, an "end of cycle" pop-up appears with HACCP data and the unit runs in storage mode at an air temperature of + 3°C.

Press the On/Off key. The machine switches off and you can remove the finished product. The start screen appears on the display.

## 7.5 BLAST FREEZING CYCLE – VINTOS and VINTOS+

### Start screen



Press the "freeze" key on the start screen.

### Pop-up: preparing machine: cooling?

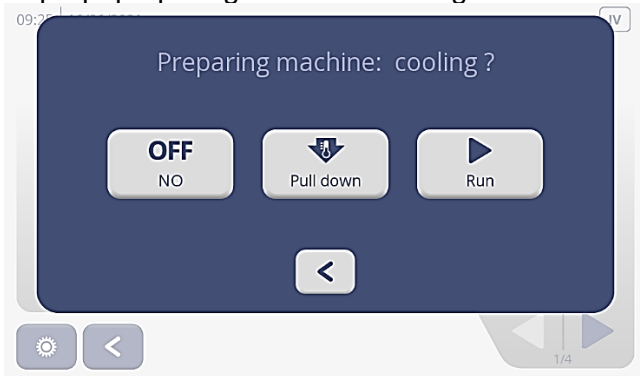

### Explanation of key commands:



"OFF / No" key  
Press to return to the start screen



"Pull down" key  
Unit pre-cools to - 30°C

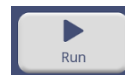

"Run" key  
Unit starts the blast freezing cycle

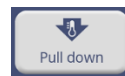

"Pull-down" key  
Press and the unit starts.

### Pop-up: preparing machine: cooling



The display shows the air temperature. When the setpoint of -30°C is reached, the window preparing machine: cooling pops up.

Press "Run".

The display shows the product selection with preset recipes for blast freezing various products, a manual function as well as the smart level control function.



Use the arrow key on the bottom right to scroll through the product selection menu and select the desired product to be frozen by pressing the corresponding key.

After selecting by pressing the key, the pop-up HACCP recording opens.



## Pop-up: HACCP recording

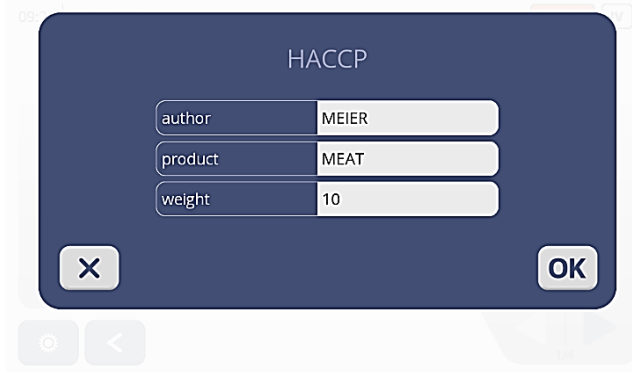

A dark blue pop-up window titled "HACCP" with three input fields: "author" with the value "MEIER", "product" with the value "MEAT", and "weight" with the value "10". There are "X" and "OK" buttons at the bottom.

Fill in the input mask:

- employee (Author)
- product
- weight

Confirm with the "OK" key.

Place the product in the unit, place the core probe in the product.

The corresponding cycle interface appears on the display.

## Cycle interface: freeze

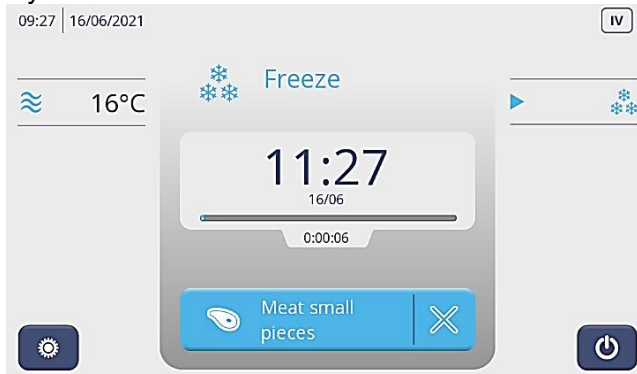

Center, large digits: calculated end time

Small digits: date of end of cycle

The displayed time may change repeatedly during the cycle depending on the progress and core temperature.

The elapsed time is displayed below the bar.

### Left side:

Display of the air temperature and below of the core temperature probe (if it has been inserted).

The controller automatically detects whether the core probe has been inserted and displays this after a running time of 5 min. If the core probe has not been inserted and detected, the time programme cycle runs automatically.

### Right side:

The individual steps of the cycle are displayed. The small, light blue arrow and the light blue snowflakes indicate the unit's current cycle step.

The blue product key takes you to the set cycle steps.

## Cycle step: freeze

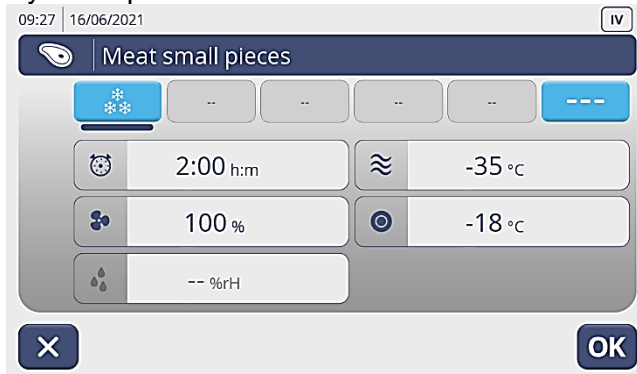

The dark blue line below the snowflakes indicates which step of the cycle the controller is in.

You can use the corresponding key to select which step of the cycle you want to view and / or change.

## Cycle step: store frozen products



In each step of this cycle, you can change or individually adapt the following for the current cycle by pressing the corresponding field:

- time
- fan speed
- air temperature
- core temperature (probe)

## Pop-up: air setpoint



By pressing the "air setpoint" key for example, the "air setpoint" window pops up.

Enter the desired value.

First the digits, then the negative (-) sign.

Press "OK" to save the entered value. The display jumps back one step to the cycle steps interface. Pressing the OK key again takes you back to the cycle interface: freeze

## End of cycle: freeze

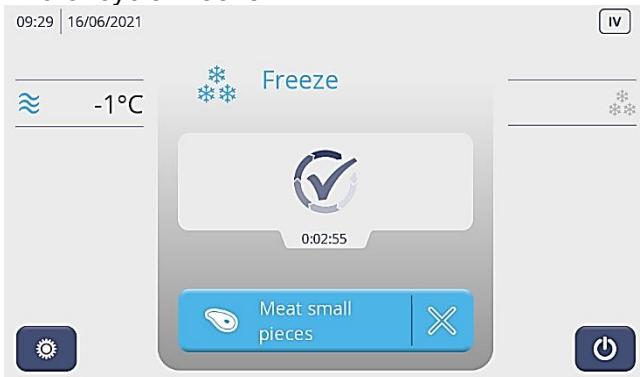

At the end of the cycle, the pop-up appears: end of cycle with HACCP data. The unit runs in storage mode at an air temperature of -18°C.



By pressing the On/Off key the unit switches off. The finished product can be removed. The start screen appears on the display.

## 7.6 COMBINED CYCLE – VINTOS+

### Start screen



Press the "combi" key.

### Pop-up: preparing unit: heating?

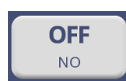
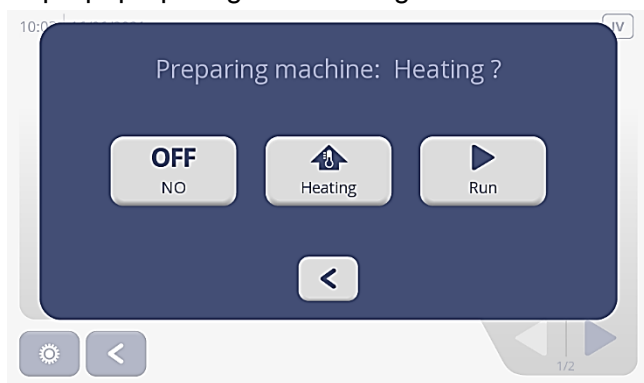

"OFF/No" key  
Press to return to start screen



"Heating" key  
Unit pre-heats to 60°C



"Run" key  
Unit immediately starts the combined cycle

### Pop-up: preparing machine: heating

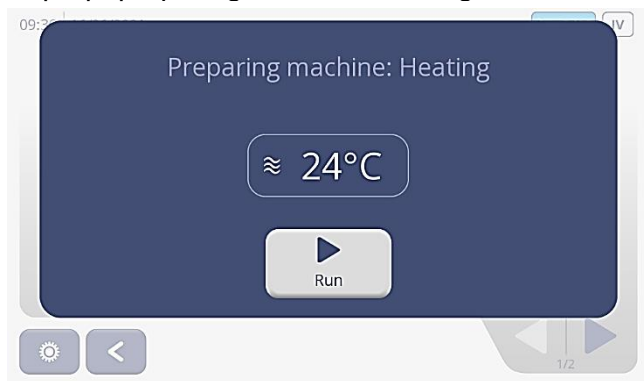

The display indicates the air temperature. Once it reaches the set value of 60°C, the pop-up "machine ready" appears.

### Pop-up: machine ready: heated

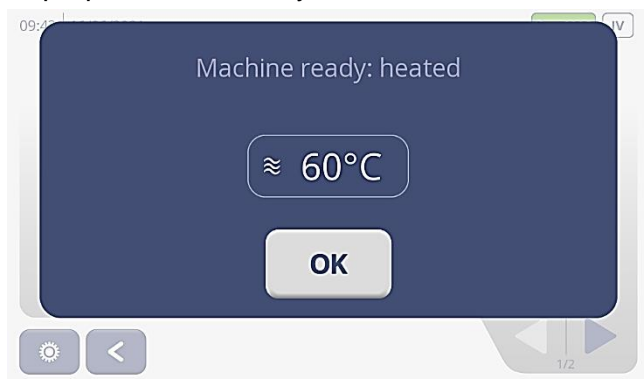

Press "OK", the display shows the product selection with the corresponding preset combination recipes of the various products as well as a manual function.

## Product selection



Use the arrow key on the bottom right to scroll through the product selection menu and choose the appropriate product by pressing the key.

The pop-up for the HACCP recording appears.

## Pop-up: HACCP



Fill in the input mask:

- employee (author)
- product
- weight

Confirm with the OK key.

Place the product in the unit, place the core probe in the product.

The corresponding cycle interface appears in the cycle.

## Cycle interface combi

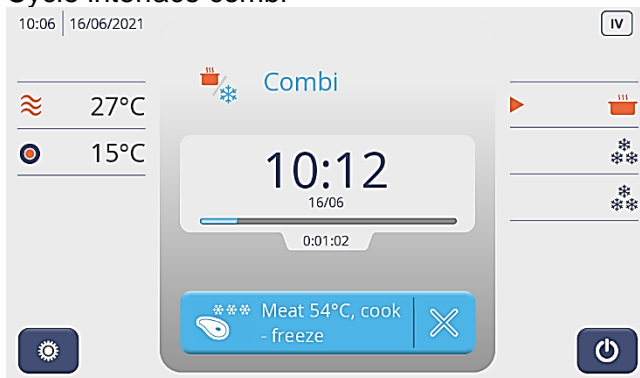

Center, large digits: calculated end time  
Small digits: date of end of cycle

The displayed time may change repeatedly during the cycle depending on the progress and core temperature.

The elapsed time is displayed below the bar.

### Left side:

Display of the air temperature and below of the core temperature probe (if it has been inserted).

The controller automatically detects whether the core probe has been inserted and displays this after a running time of 5 min. If the core probe has not been inserted and detected, the time programme cycle runs automatically.

### Right side:

The individual steps of the cycle are displayed. The small, light blue arrow and the light blue snowflakes indicate the unit's current cycle step.

The blue product key takes you to the set cycle steps.

## Cycle stages combined

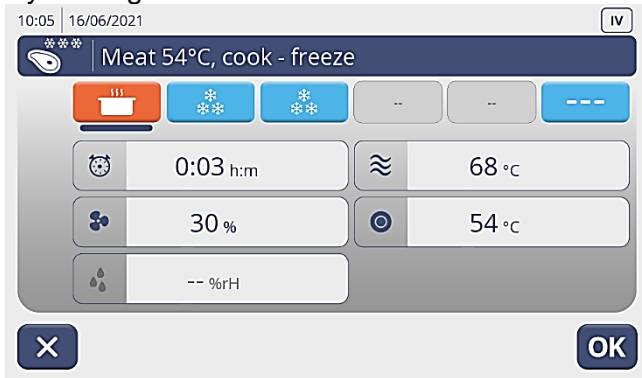

The dark blue line below the pot or the snowflake indicates which step of the cycle the controller is in.

You can use the corresponding key to select which step of the cycle you want to view and / or change.

In each step of this cycle, you can change or individually adapt the following for the current cycle by pressing the corresponding field:

- time
- fan speed
- air temperature
- core temperature (probe)

## Pop-up: change values "air setpoint"



By pressing the "air setpoint" key for example, the "air setpoint" window pops up.

Enter the desired value.

First the digits, then the negative (-) sign.

Press "OK" to save the entered value. The display jumps back one step to the cycle stages interface. By confirming with the OK key again, you return to the cycle interface "combi".

## End of cycle: combi



At the end of the cycle, the pop-up appears: end of cycle with HACCP data. The unit runs in storage mode at the preset air temperature.

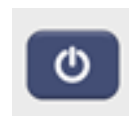

By pressing the On/Off key, the unit switches off. The finished product can be removed. The start screen appears on the display.

## 7.7 SLOW SPEED COOKING CYCLE – VINTOS+

### Start screen



Press "slow speed cooking" key.

### Pop-up: preparing machine: heating?

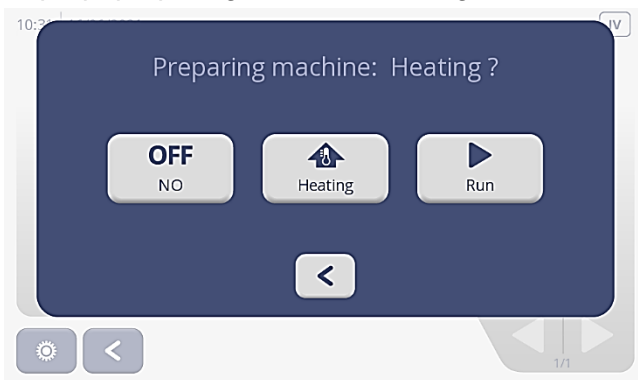

"OFF/NO"

Press to return to start screen



"Heating" key

Unit pre-heats to 60°C



"Run" key

Unit immediately runs the slow speed cooking cycle.

### Pop-up: preparing machine: heating



The display shows the air temperature. Once the set value of 60°C is reached, the pop-up "machine ready: heated" opens.

### Pop-up: machine ready: heated

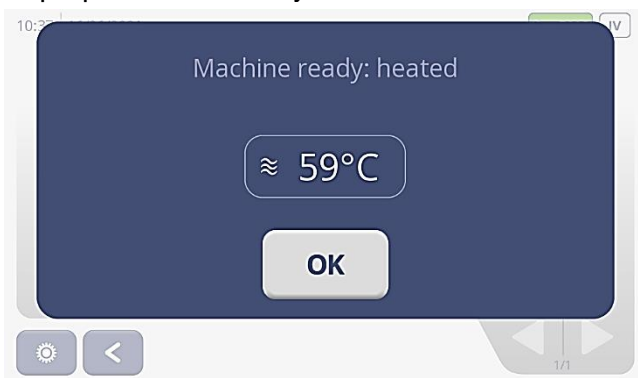

Press "OK", the display shows the product selection menu with the corresponding preset recipes for slow speed cooking of various products as well as a manual function and the smart level control function.

### Product selection menu



Use the arrow key at the bottom right to scroll through the product selection menu and select the appropriate product by pressing corresponding key.

The pop-up for HACCP recording appears.

### Pop-up: HACCP

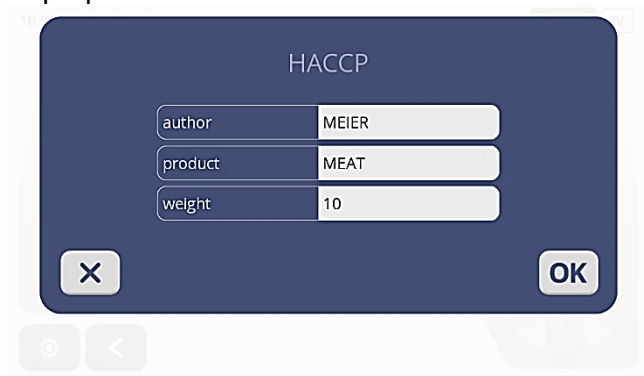

Fill in the input mask:

- employee (author)
- product
- weight

Confirm with the "OK" key.

Place the product inside the unit, place the core probe in the product.

The corresponding cycle interface appears in the cycle.

### Cycle interface slow speed cooking



Center, large digits: calculated end time  
Small digits: date of end of cycle

The displayed time may change repeatedly during the cycle depending on the progress and core temperature.

The red bar below the date shows the time range of where the process is at.

The elapsed time is displayed below the red bar.

#### Left side:

Display of the air temperature and below of the core temperature probe (if it has been inserted).

The controller automatically detects whether the core probe has been inserted and displays this after a running time of 5 min. If the core probe has not been inserted and detected, the time programme cycle runs automatically.

#### Right side:

The individual steps of the cycle are displayed. The small red arrow indicates the unit's current cycle step.

The red product key takes you to the set cycle steps.

### Cycle step: slow speed cooking

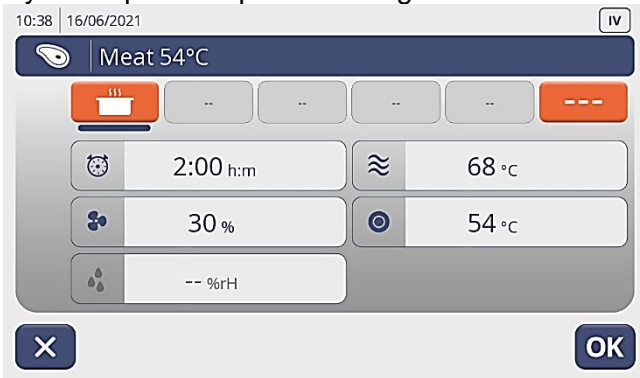

The dark blue bar below the pot indicates which step of the cycle the controller is in.

You can use the corresponding key to select which step of the cycle you want to view and / or change.

In each step of this cycle, you can change or individually adapt the following for the current cycle by pressing the corresponding field:

- time
- fan speed
- air temperature
- core temperature (probe)

### Pop-up: change values "air setpoint"



By pressing the "air setpoint" key for example, the "air setpoint" window pops up.

Enter the desired value.

First the digits, then the negative (-) sign.

Press "OK" to save the entered value. The display jumps back one step to the cycle stages interface. By confirming with the OK key again, you return to the cycle interface slow speed cooking.

### End of cycle: slow speed cooking



At the end of the cycle a pop-up appears: End of cycle with HACCP data. The unit runs in storage mode at the preset air temperature.

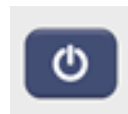

By pressing the On/Off key, the unit switches off. The finished product can be removed. The start screen appears on the display.



## 7.8 THAW CYCLE – VINTOS+

### Start screen



Press the "thaw" key.

### Product selections menu

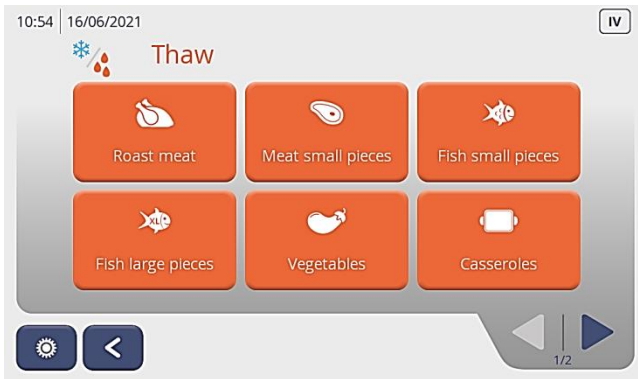

Select product and confirm the selection by pressing the corresponding key.

The pop-up "ready at" appears on the display for entering as to when you need the product thawed.

### Pop-up: ready at

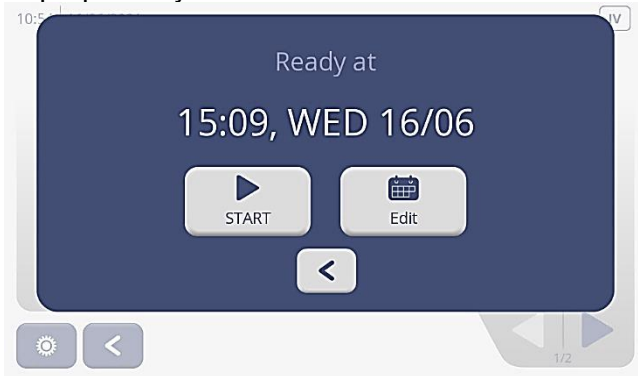

"Start" key  
The unit starts the thaw cycle and finishes at the displayed time.

Pop-up HACCP opens.

### Pop-up HACCP



Fill out the input mask:

- employee (author)
- product
- weight

Press the "OK" key to confirm.

On the display the cycle interface thaw appears

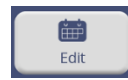
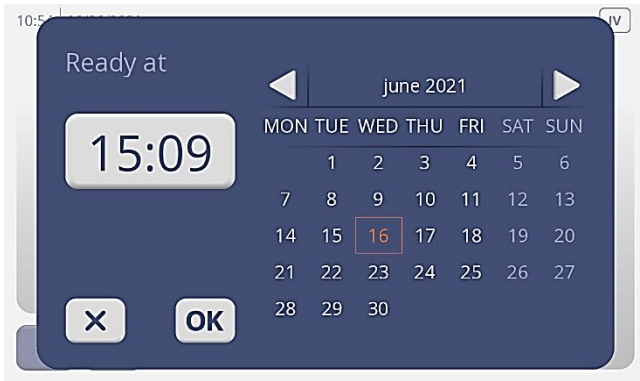

"Edit" key  
Pop-up to enter date and time appears.

The desired end time can be set.

Confirm entries with "OK".

The HACCP input screen pops up.

### Cycle interface thaw

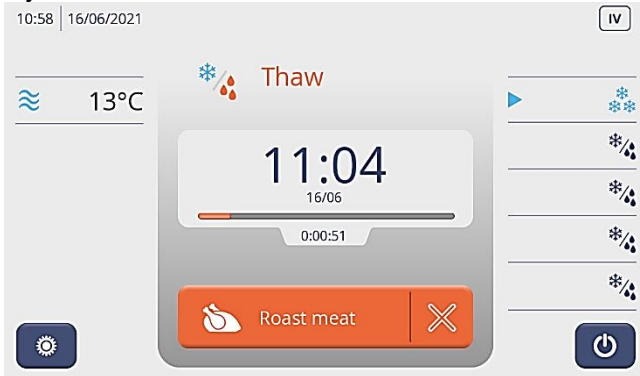

Center, large digits: set end time  
Small digits: date of end of cycle

The red bar below the date shows the time range of where the process is at.

The elapsed time is displayed below the bar.

#### Left side:

Display of the air temperature. A core temperature probe cannot be used during thawing.

#### Right side:

The individual cycle steps are displayed.

The small blue or red arrow indicates the unit's current cycle step.

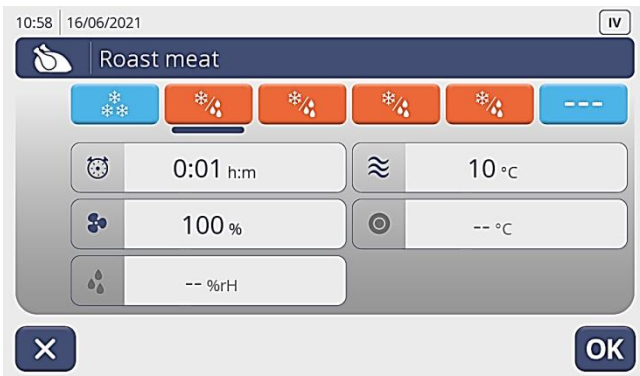

The red product key takes you to the set cycle steps.

The dark blue line below the freeze/thaw symbol indicates which step of the cycle the controller is in.

You can use the corresponding key to select which step of the cycle you want to view and / or change.

In each step of this cycle, you can change or individually adapt the following for the current cycle by pressing the corresponding field:

- time
- fan speed
- air temperature

## Pop-up: change values "air setpoint"



By pressing the "air setpoint" key for example, the "air setpoint" window pops up. Enter the desired value.

First the digits, then the negative (-) sign.

Press "OK" to save the entered value. The display jumps back one step to the cycle stages interface. By confirming with the OK key again, you return to the cycle interface "thaw".

## End of cycle: thaw

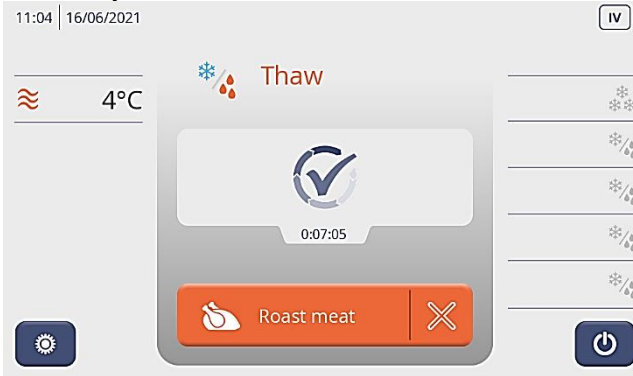

At the end of the cycle, the pop-up appears: End of cycle with the HACCP data. The unit runs in storage mode at an air temperature of +3°C.



By pressing the "On/Off" key, the unit switches off. The finished product can be removed. The start screen appears on the display.

## 7.9 PROVE CYCLE – VINTOS+

### Start screen

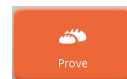

Press the "prove" key.

### Product selection menu

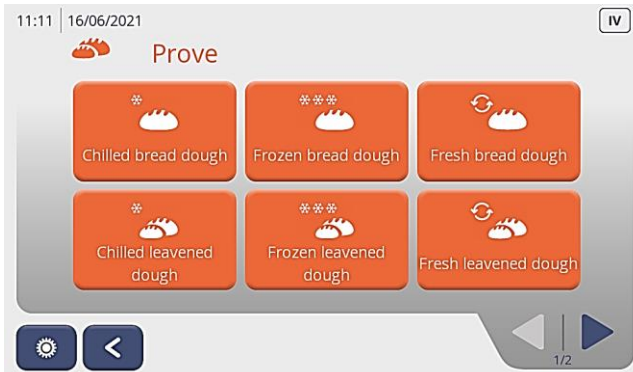

Select product and confirm the selection by pushing the corresponding key.

The pop-up "ready at" appears on the display for entering as to when you need the product for further processing.

### Pop-up: ready at

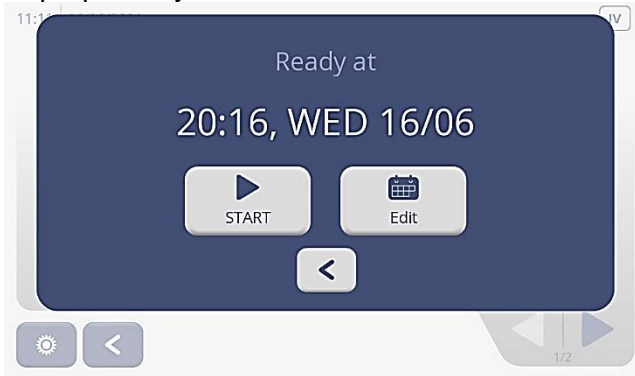

"Start" key  
The unit starts the process and finishes at the displayed time.

Pop-up HACCP opens.

### Pop-up HACCP



Fill out the input mask:  
- employee (author)  
- product  
- weight

Press the "OK" key to confirm.

The display shows the cycle interface: prove.

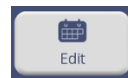
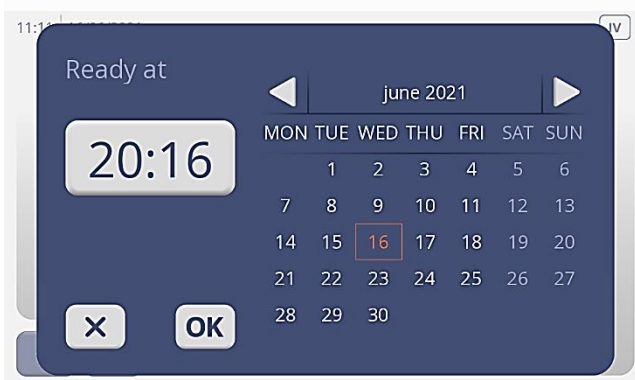

"Edit" key  
Pop-up to enter the date and time.

The desired end time can be set.

Confirm entries with "OK".

The HACCP input screen pops up.

### Cycle interface prove

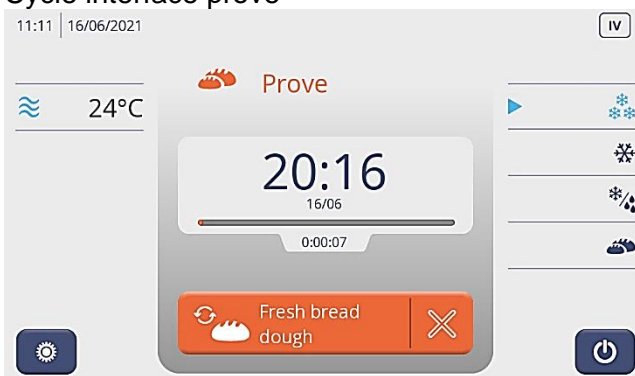

Center, large digits: set end time  
Small digits: date of end of cycle

The red bar below the date shows the time range of where the process is at.

The elapsed time is displayed below the bar.

### Left side:

Display of the air temperature. A core temperature probe cannot be used during proving.

### Right side:

The individual cycle steps are displayed.

The small blue or red arrow indicates the unit's current cycle step.



The red product key takes you to the set cycle steps.

The dark blue line below the freeze / thaw symbol indicates which step of the cycle the controller is in.

You can use the corresponding key to select which step of the cycle you want to view and / or change.

In each step of this cycle, you can change or individually adapt the following for the current cycle by pressing the corresponding field:

- time
- fan speed
- air temperature

### Pop-up: change values "air setpoint"



By pressing the "air setpoint" key for example, the "air setpoint" window pops up. Enter the desired value.

First the digits, then the negative (-) sign.

Press "OK" to save the entered value. The display jumps back one step to the cycle stages interface. By confirming with the OK key again, you return to the cycle interface prove.

### End of cycle: prove

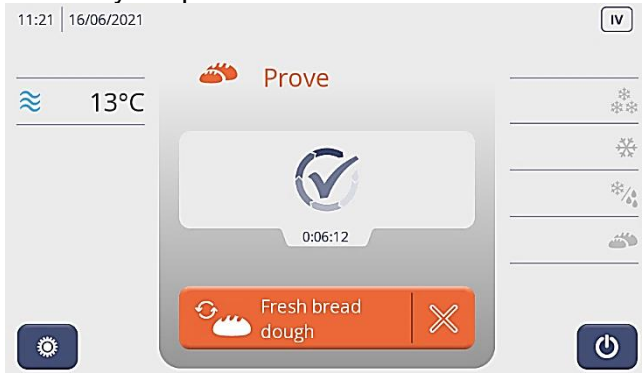

At the end of the cycle, the pop-up appears: end of cycle with HACCP data. The unit runs in storage mode at the set air temperature.

By pressing the "On/Off" key, the unit switches off. The finished product can be removed. The start screen appears on the display.



## 7.10 STORAGE CYCLE – VINTOS+

### Start screen



Press the arrow keys on the bottom right to get to the second page of the start screen.

- storage
- defrost
- sterilization

### Start screen page 2



Press "storage" key. A selection menu opens up.

### Selection menu



Make your selection:

- chill
- freeze
- warm

Depending on your selection, a pop-up appears:

- "preparing machine: cooling?"
- "preparing machine freezing?"
- "preparing machine: heating?"

### Pop-up: preparing machine: cooling?

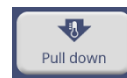
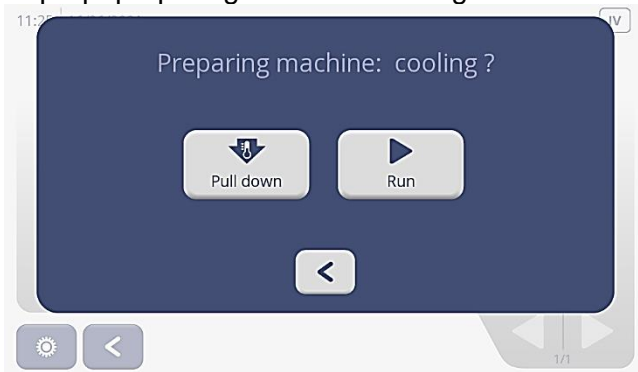

Press "Pull down" key. Unit starts.

Once the set setpoints of

- + 3°C chill
- 18°C freeze
- +60°C heat

are reached, the pop-up "machine: pre-cooled" appears.

Press "OK" and the cycle interface storage appears on the display.

### Cycle interface "storage"

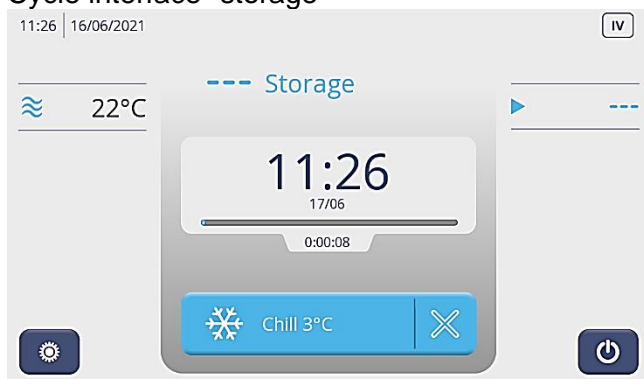

Center:  
Large digits: set end time  
Small digits: date of end of cycle

**Please note!**  
**Storage cycles are limited to 24h at the most.**

The blue bar below the date shows the time range of where the process is at.

The elapsed time is displayed below the bar.

#### Left side:

Display of the air temperature.

#### Right side:

The blue arrow key takes you to the set cycle steps.

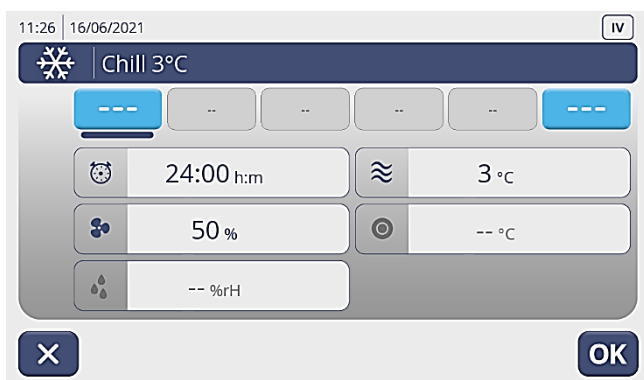

The dark blue line below the symbol indicates which step of the cycle the controller is in.

In each step of this cycle, you can change or individually adapt the following for the current cycle by pressing the corresponding field:

- time
- fan speed
- air temperature

### Pop-up: change values "air setpoint"



By pressing the "air setpoint" key for example, the "air setpoint" window pops up. Enter the desired value.

First the digits, then the negative (-) sign.

Press "OK" to save the entered value. The display jumps back one step to the cycle stages interface. By confirming with the OK key again, you return to the cycle interface storage.

### End of cycle: storage



At the end of the cycle a pop-up appears: "storage".

**The unit is not suitable for extended periods of storage!**

 By pressing the "On/Off" key, the unit switches off. The finished product can be removed. The start screen appears on the display.

## 7.11 DEFROST CYCLE – VINTOS and VINTOS+

### Start screen



Press the arrow keys on the bottom right to get to the second page of the start screen.

- storage
- defrost
- sterilization

### Start screen page 2

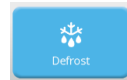
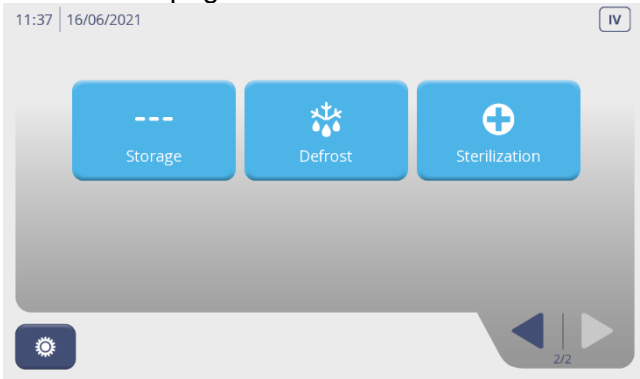

Press "defrost" key.  
The cycle interface „defrost" opens.  
The evaporator fans run at full speed.  
Open the door until the defrost process is finished after max. 15 min. and the pop-up "defrost finished" appears.

### Cycle interface "defrost"



Center

Large digits: calculated end time  
Small digits: date of end of cycle

The blue bar below the date shows the time range of where the process is at.

The elapsed time is displayed below the bar.



By pressing the on/off key, the unit switches off.  
The start screen appears on the display.



## 7.12 STERILIZATION CYCLE – VINTOS+

### Attention!

Before starting the sterilization cycle, remove all food products from the unit and clean the interior thoroughly. (See chapter 8.2. Cleaning)

### Start screen



Press the arrow keys on the bottom right to get to the second page of the start screen.

- storage
- defrost
- sterilization

### Start screen page 2

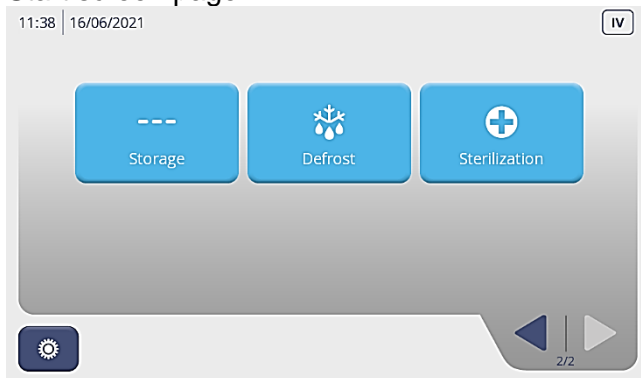

General information:

"Sterilization" key is highlighted in blue  
The air temperature is above +15°C. The process can be started.

"Sterilization" is highlighted in gray  
The air temperature is below +15°C. The process cannot be started.

 The cycle interface "sterilization" opens. The evaporator fans run at low speed and the ozone is fed into the interior. Please keep the unit's door closed until the cycle is finished after approx. 15 min.

Press the "Sterilization" key.

### Cycle interface "Sterilization"

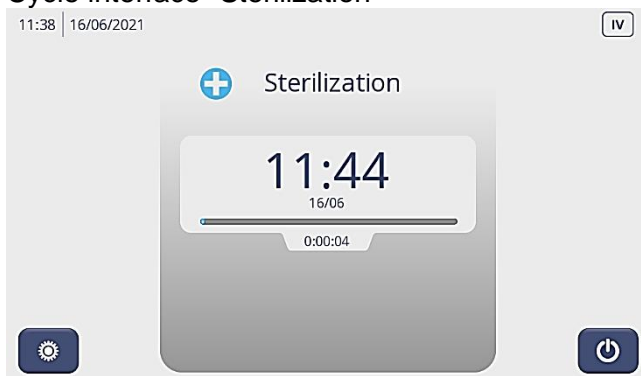

Center

Large digits: calculated end time  
Small digits: date of end of cycle

The blue bar below the date shows the time range of where the process is at.

The elapsed time is displayed below the bar.

 By pressing the on/off key, the unit switches off. The start screen appears on the display.

### 7.13 SMART LEVEL CYCLE – VINTOS and VINTOS+

The smart level control mode is available for blast chilling, blast freezing and slow speed cooking. In this mode, you have the option of setting different times and products for the respective inserted load. This allows for a time-controlled function for the product and it can be loaded and unloaded with different products at differently timed insertion intervals.

Furthermore, the room temperature can be selected at will based on your experience. Once the individual times have elapsed, you receive a ready message for each inserted load and the product can be removed.

Start screen



Select cycle

- blast chilling
- blast freezing
- slow speed cooking

Pop-up: preparing machine: cooling?

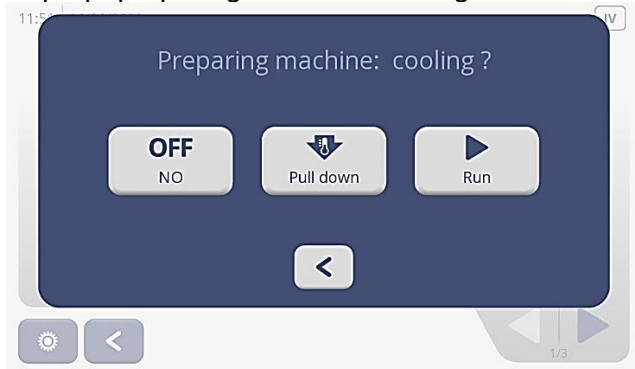

"OFF / NO" key  
Return to the start screen

"Pull down" key  
Unit pre-cools to -15°C

"Start" key  
Unit immediately starts the blast chilling cycle

Pop-up: prepare machine: cooling



Press "Pull down"

The unit starts running.

The air temperature of the unit is indicated on the display. If the set target value has been reached, the pop-up "unit pre-cooled" appears.

Pressing the "run" key takes you to the product selection with the corresponding preset recipes for blast chilling various products, a manual function as well as the smart level control function.

Product selection page 1

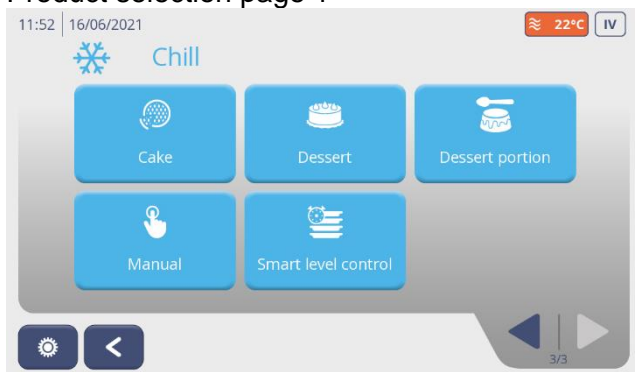

Use the arrow key on the bottom right to scroll through the product selection and to select the smart level control function.

## Product selection page 3



Press the "smart level control" function key.

You get to the smart level control function interface which displays the number of insertion levels (slots) corresponding to your model unit.



This key allows you to set the fan speed and the air temperature individually.

## Pop-up: room temperature / fan speed SLC



You can change the factory setting of the two parameters.

Factory settings:

Blast chilling  
-15°C air temperature  
100% fan speed

Blast freezing  
-30°C air temperature  
100% fan speed

Slow speed cooking + proving  
+60°C air temperature  
40% fan speed

Confirm with "OK" key.

## Pop-up: product and duration smart level control



Select the insertion level (slot) that you want to load and enter on the display that pops up the product and the duration for the product you are loading.

These entries can now be made for any level (slot) and at any time of the cycle.

With the right arrow key confirm your entries and return to the overview.

### Overview smart level control



The selected levels (slots) are now highlighted in yellow and the product as well as the remaining time for each occupied level (slot) is being displayed.

Once the time of one level (slot) has elapsed, a pop-up opens with a ready message for this level (slot).

### Pop-up: level ready: smart level control

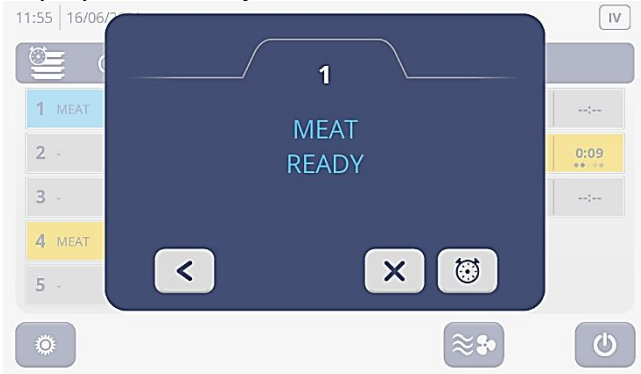

extend the time



delete entry



back to the overview smart level control

### Overview smart level control



The finished levels (slots) are highlighted in blue with a check mark in the time column.

The On/Off key ends the smart level control cycle.

## 7.14 MANUAL CYCLE – VINTOS and VINTOS+

### Start screen



### Select cycle

- chill
- freeze
- thaw
- combi
- slow speed cooking
- prove

### Pop-up: preparing machine: cooling?

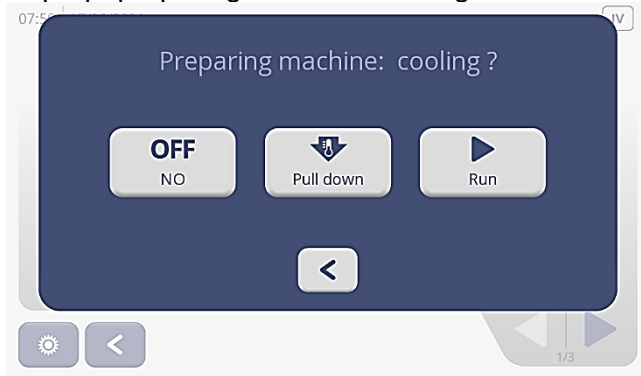

### "Off / No" key

Return to the start screen

### "Pull down" key

Unit pre-cools to -15°C

### "Start" key

Unit immediately starts the blast chilling cycle

Press "Pull down" key.

### Pop-up: preparing machine: cooling



The unit starts running.

The air temperature is indicated on the display. If the set target value has been reached, the pop-up "unit pre-cooled" appears.

Pressing the "run" key takes you to the product selection menu with the corresponding preset recipes for blast chilling various products, a manual function as well as the smart level control function.

### Product selection page 1

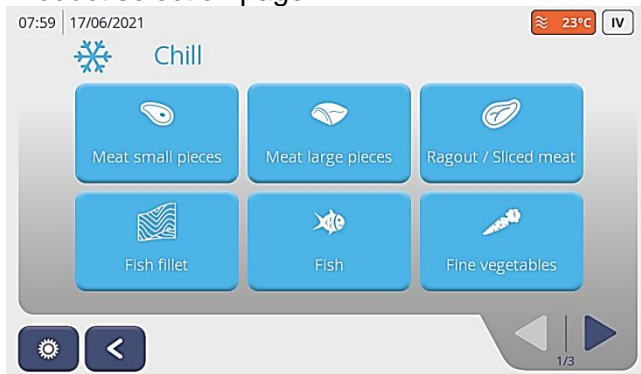

Use the arrow key on the bottom right to scroll through the product selection menu and to select the "manual" function.

## Product selection page 3 with "manual"



## Interface manual

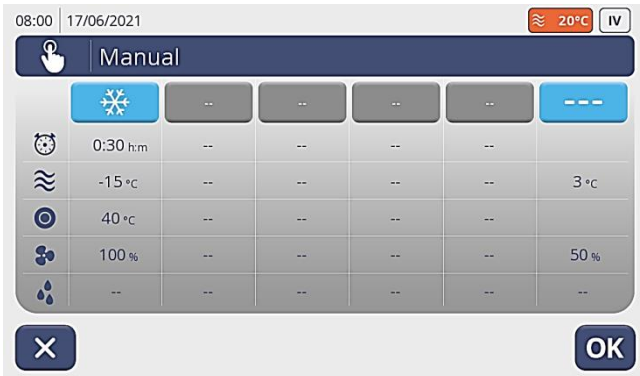

Light blue key  
Press chill or freeze key.

## Settings manual programme

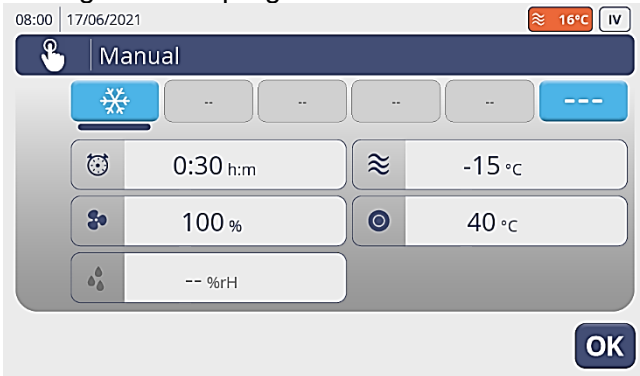

You can enter the following settings:

- time
- air temperature
- core temperature
- fan speed

Confirm your entries by pressing the "OK" key.

Press the „clock“ symbol

## Pop-up: Manual programme, setting the time



After entering the appropriate setting in the pop-up, press "OK" and your settings are saved and the interface manual appears again on the display.

Press the "OK" key again to start the programme.

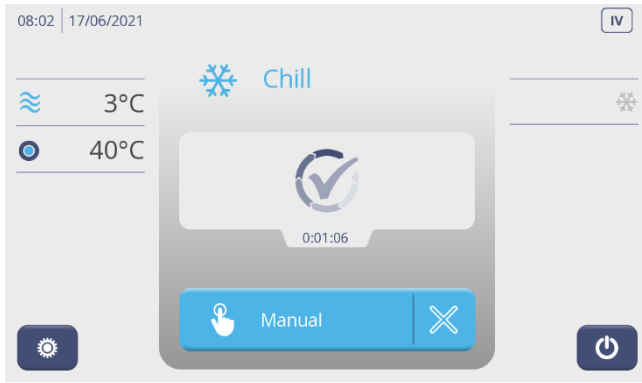

At the end of the cycle, the pop-up "end of cycle chill" appears.

## 7.15 DUPLICATE PROGRAMMES / WRITE OWN PROGRAMMES – VINTOS and VINTOS+

### Start screen



Select cycle

- chill
- freeze
- thaw
- combi
- slow speed cooking
- prove

### Pop-up: preparing machine: cooling?

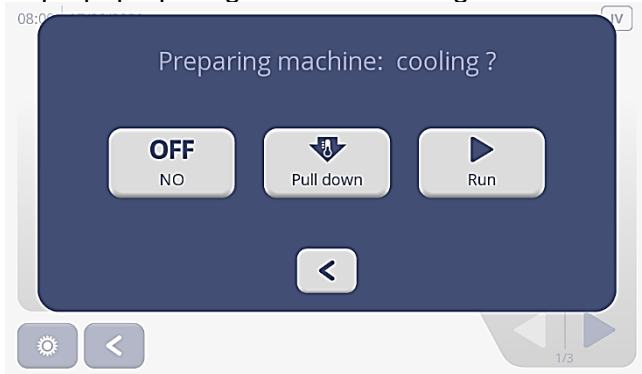

"OFF / NO" key

Press and the product selection menu opens up.

### Window: product selection menu



With the arrow key on the bottom right, you can scroll through the product selection menu and choose a programme.

Copy/write programmes

Press the selected programme key (e.g. meat small pieces) for 5 seconds.

### Pop-up: edit / duplicate

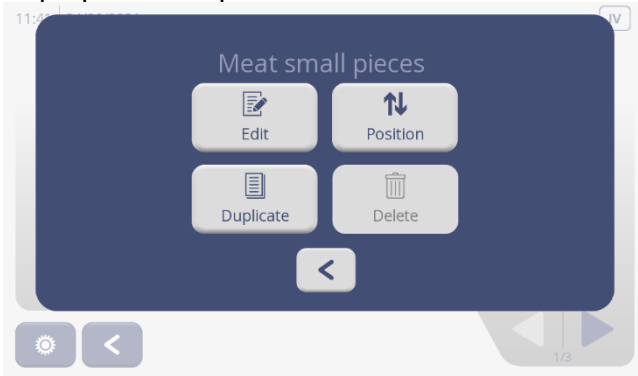

On a screen that pops up, you can edit the selected programme as follows:

- duplicate
- edit
- delete
- move position

To write your own programme or to copy the programme press "duplicate".

### Pop-up: keyboard



A window pops up where you can enter a new name for your programme.

Use the keyboard to enter a new name, e.g. Schnitzel.

Confirm with "OK" key.

### Window: programme steps



A window pops up with the individual steps of the programme.



To assign a new logo, press the logo icon next to the name you have assigned to your programme.

### Window: selecting logos for the programme



With the arrow keys on the bottom right, you can scroll through the logo pages.

Choose your selection by pressing the icon. The programme applies the selected logo and returns to the window with the individual programme steps.



### Window: programme steps



Each step of the programme can be customized by pressing the upper light blue or red buttons with the cooling / freezing or heating symbol.

One window at a time pops up in which the

- time
- air temperature
- evaporator fan speed
- core temperature

can be set and applied to each respective step

### Settings new programme

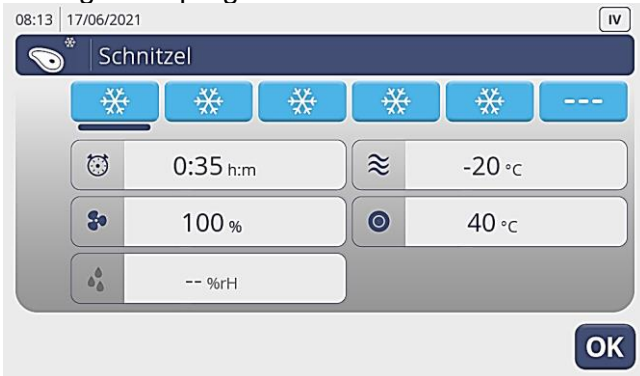

You can change each value by pressing the corresponding key.

Respective pop-ups for setting the values open up.

### Pop-up: air setpoint



Check each programme step and change the values for your new programme.

As soon as all programme steps are set, confirm your settings with the "OK" key.

The programme jumps back to the page with the programme steps.

Check once more if all steps are correct. Confirm with "OK".

### Window: product selection menu

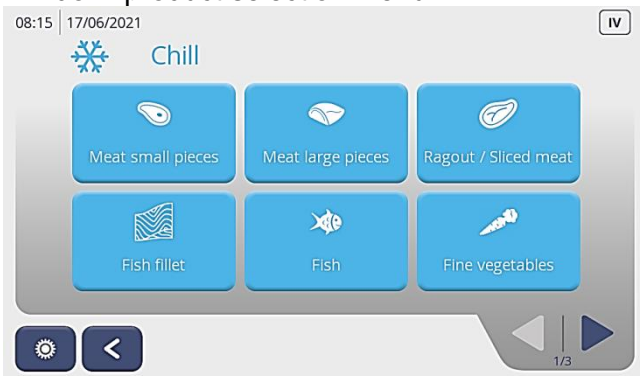

Use the arrow keys on the bottom right to scroll through the product selection menu until your new programme appears.

Window: product selection page 3

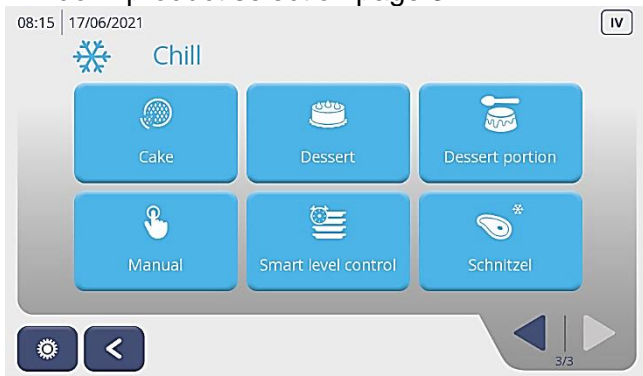

In our example on page 3 "Schnitzel" programme.

Your new programme can be started normally. Refer to Chapter 7.4 Blast Chilling Cycle

7.16 EDIT OWN PROGRAM – VINTOS and VINTOS+

Start screen



Select cycle

- chill
- freeze
- thaw
- combi
- slow speed cooking
- prove

Pop-up: preparing machine: cooling?

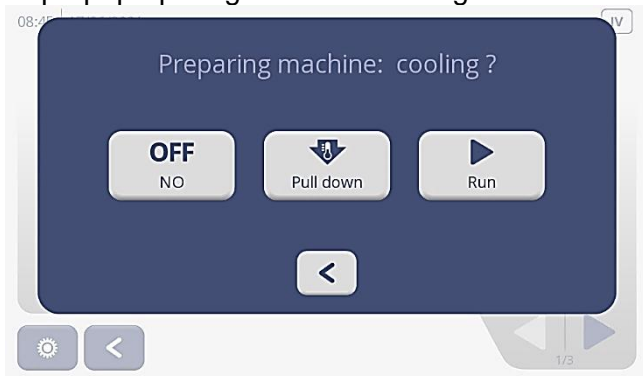

"OFF/NO" key. Press and the product selection menu opens up.

Window: product selection

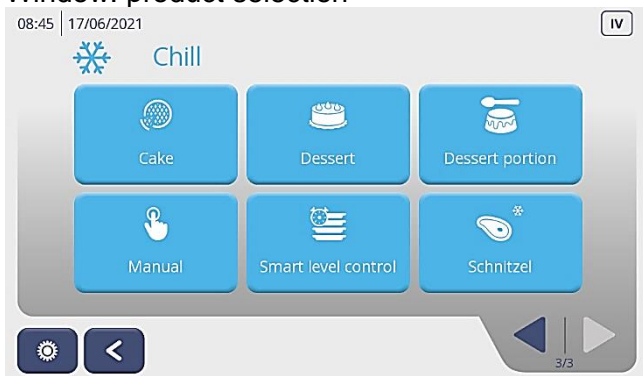

With the arrow key on the bottom right, you can scroll through the product selection menu and select a programme.

Press the key of the selected programme you want to edit (e.g. meat small pieces) for 5 seconds.

### Pop-up: edit / duplicate

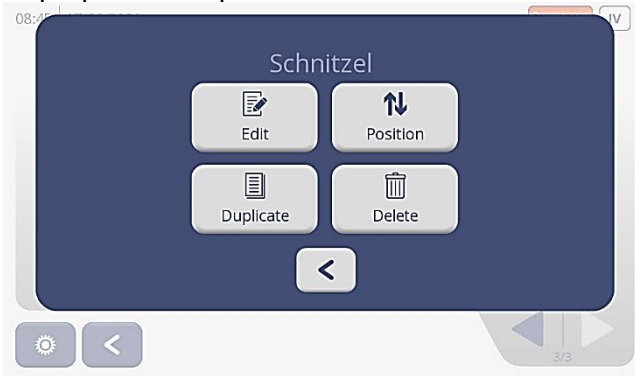

On a screen that pops up, you can edit the selected programme as follows:

- duplicate
- edit
- delete
- move position

Press "edit" and the window with the corresponding programme steps pops up.

### Window: programme steps



Each step of the programme can be customized individually by pressing the upper light blue or red buttons with the cooling/freezing or heating symbol.

One window at a time pops up where time, air temperature, evaporator fan speed and core temperature can be set and applied to each respective step.

### Window: settings

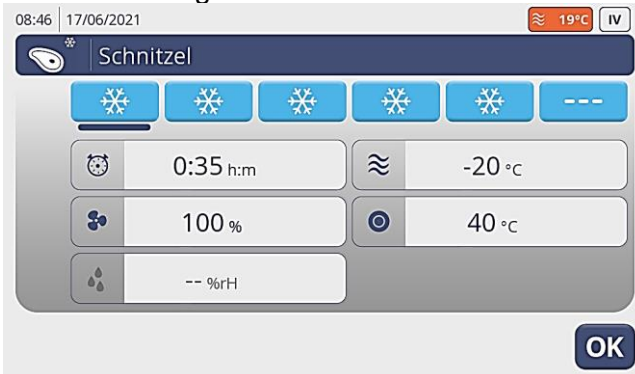

You can now change each value by pressing the corresponding key. A pop-up for setting the respective values then opens.

Check each programme step and change the values for your new programme.

When all programme steps have been set, save your settings by pressing the "OK" key. The programme jumps back to the programme steps page.

### Window: product selection

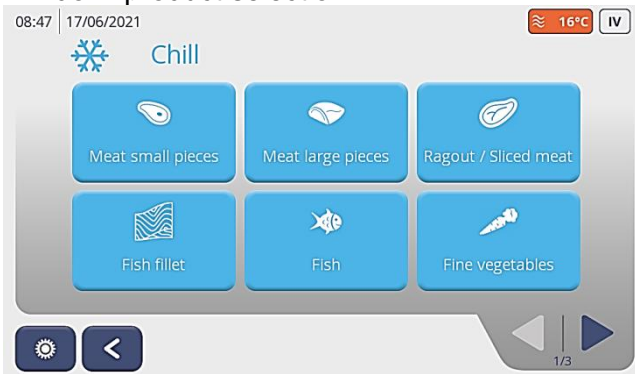

Check once more if all settings are correct and confirm with "OK".

The programme jumps back to the product selection menu.

## 7.17 MOVE PROGRAMMES IN THE PRODUCT SELECTION

The programme you have created as well as all other programmes can be moved within the product selection interface so that the programmes you use the most appear on the first page.

### Window: product selection



On the product selection menu, press the key of the programme you want to move for 5 seconds. e.g. Schnitzel.

### Pop-up: move position

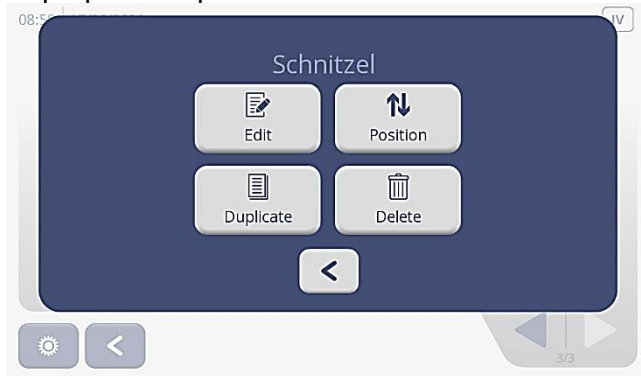

Press the "position" key.

Another window pops up.

Use the left arrow key to return to the product selection menu.

### Pop-up: enter position



Enter the desired position. e.g. "1"

Confirm with "OK".

The programme jumps back to the previous pop-up: "position"

### Window: product selection



Your programme is now in 1st position on the product selection menu.

## 7.18 DELETE PROGRAMMES IN THE PRODUCT SELECTION

### Window: product selection



On the product selection menu, press the key of the programme you want to delete for 5 seconds. e.g. Schnitzel.

### Pop-up: delete position

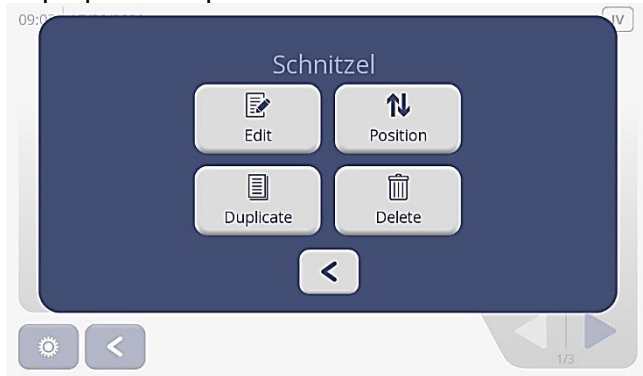

Press "delete" key.

Another window pops up.

### Pop-up: delete recipe



Delete recipe "Schnitzel"?

Press the "OK" key to delete the programme. The product selection menu appears again on the display.

### Window: product selection



Return to the start screen by pressing the left arrow key or choose and start a desired program.

## 7.19 BASIC SETTINGS OF THE CONTROLLER

In the controller menu, all parameters of the control can be viewed and set. The access options are divided into four levels, each pending the access release by the customer or the manufacturer.

### Level I

User level and accessible without password. Only the set programmes are accessible. No changes or settings can be made.

### Level II

Chef level and accessible with a password (1000). This level is set at delivery from the factory. This means that all for the operator possible settings are accessible. In level II, own programmes can be written, manual programs created, smart level control settings and basic settings (such as date and time) set.

### Level III

Is also protected by a password (2000) and is intended for maintenance and repair by a technician. All parameters can be viewed and some important parameters can be changed.

### Level IV

Is protected by a password and only accessible to the factory and the factory service. On this level, all values and parameters can be viewed and changed.

The passwords of level II and III can be changed and saved. The password on level IV cannot be changed. To enter and change the passwords, proceed as follows.

On the start screen, in the top right corner the current level is displayed. In this example, level IV.

Window: start screen



On the bottom left, press the menu key to change levels or passwords.

The first menu page opens.

Window: menu page 1 on level IV

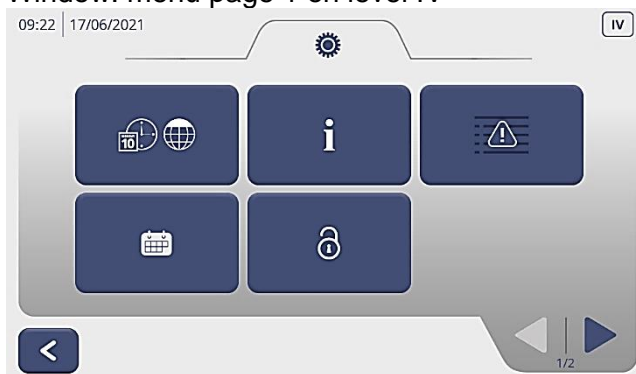

Clock

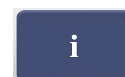

Info



Calendar



Alarms



Password



The arrow key takes you to menu page 2, with the Test and Set menu keys. All selectable keys are highlighted in blue.

### Pop-up: login interface

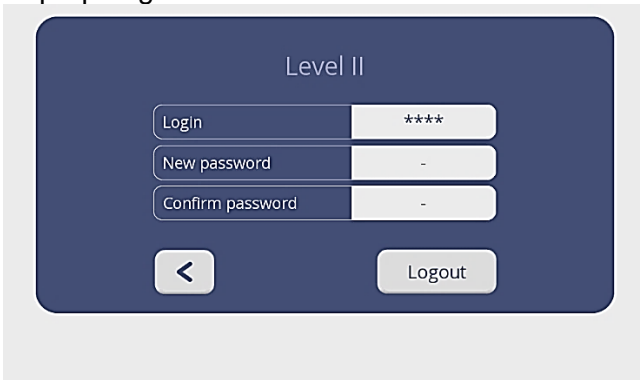

Press the password key.  
The graphic indicates the current level. Below are the fields:

- login
- new password
- confirm password

as well as logout and a back arrow

### Pop-up: password



Press on login to get to another level. A pop-up will open where you can enter the corresponding password.

Passwords  
Level II: 1000  
Level III: 2000

Confirm your entry with OK and you will return to the previous password pop-up.

### Pop-up: login interface

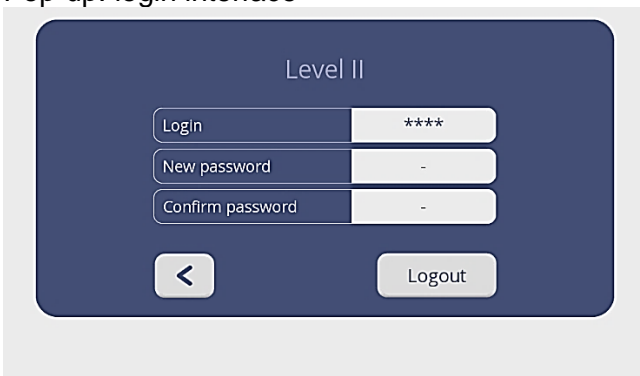

On the login interface press the left arrow key to be logged into the desired level.

Attention:  
If you press the logout button on the login screen, the control always returns to level I.

### Change password

You can change the password for levels II and III by pressing "new password" on the login screen and entering a new 4-digit password in the "password" pop-up. Press OK to confirm your entry. Then press the "confirm password" button. Enter the new password again and confirm with OK.

## 7.20 ALARM MESSAGES

Window: start screen



Press the menu key on the bottom left.

A first menu page opens up.

Window: menu page 1 on Level IV



Press menu key alarms

The window "alarm list" pops up.

Window: alarm list



Alarm list

The alarms with start and end time are being displayed.

Scroll through the list with the arrow keys at the bottom right.

Return to page 1 of the menu with the arrow at the bottom left.



## 7.21 VIEW AND CHANGE PARAMETER LIST

Window: start screen



On the bottom left press the menu key.

The first menu page opens up.

Window: menu page 1 on level IV



Open the parameter list on level IV.

Request the password from our technical customer service.

Enter the password in the password pop-up and return to the menu page.



Using the arrow key go to menu page 2

Window: menu page 2 on level IV



Press the SET key.

Window parameter list opens up.

Window: parameter list from A-G

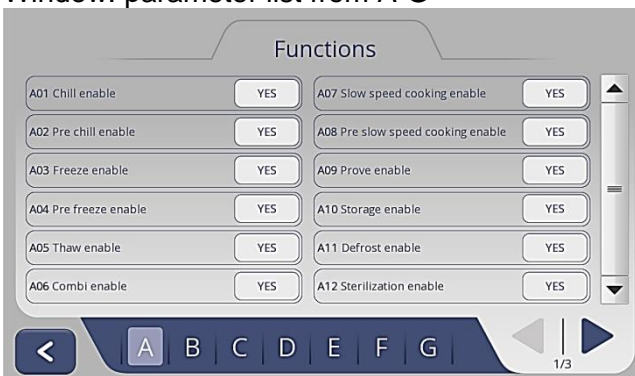

On this page there are parameters A-G.



With the arrow keys at the bottom left you can scroll through the pages and by touching the letters, you can check the parameters.

**The parameters are only to be changed after consulting the factory customer service!**

To change a parameter, press the highlighted button. One pop-up at a time opens where you can change the settings of the parameter. Confirm with OK and the window: parameter list appears again. With the arrow at the bottom left, return to the menu page.

**Attention! Whenever you have changed the control to level III or IV and you are finished on these levels, please always set the control back to level II.**

## 7.22 VIEW AND CHANGE RELAY

Window: start screen



On the bottom left press the menu key.

The first menu page opens.

Window: menu page 1 on Level IV



Using the arrow key go to menu page 2

Window: menu page 2 on level IV



Press the TEST key.  
Window relays – interface Test opens.

Window: interface Test

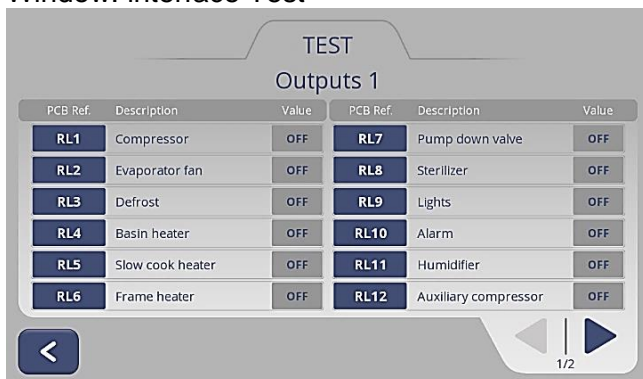

Use the arrow keys on the bottom right to scroll through the pages.

To test the relays, press one of the light gray buttons in the "value" column. The relays will then switch on and you can check whether the corresponding component is working.

**Attention!**  
**After the function test, the relays must be switched off again.**



Using the arrow key on the bottom left you return to the menu page.

**Attention! Whenever you have changed the control to level III or IV and you are finished on these levels, please always set the control back to level II.**

## 7.23 HACCP DATA EXPORT VIA USB STICK

- Open the machine or installation compartment.
- Insert the supplied USB stick into the USB port on the switch box.
- The pop-up "Download haccp logs in the USB" appears on the display.

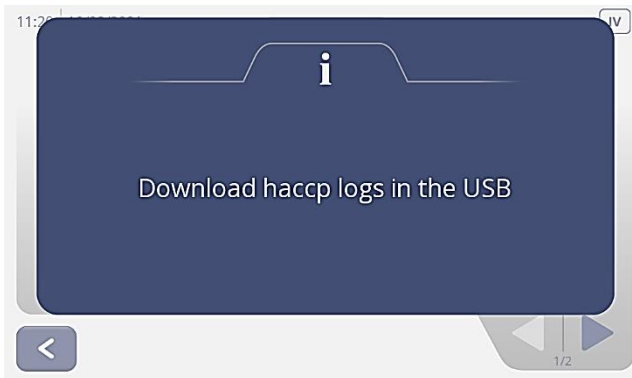

- Please note that the file "commandPU.chr" that is stored on the stick is needed for read-out and that it is not to be deleted.
- If the above file is deleted, a data export is not possible. In this case, please contact the manufacturer.
- As soon as the data export is complete, on the display a pop-up appears: "Done. It's possible to remove USB stick".



- All HACCP files are now stored as csv-files on the USP stick.
- The date of export is always specified in the file name for each HACCP file. This facilitates the differentiation from the last data export.

- Download the files from the USB stick onto your PC and open the desired files in a spreadsheet programme (e.g. Excel).
- Depending on the programme, it may be necessary to format the data. To do so, select the first column in Excel and choose the function: "Data / Texts in columns".

	A	B	C	D	E	F	G	H	I	J	K	L
1	Serial number	CC21011000										
2	Description	VINTOS PLUS SKFMEQ0811D VP										
3	Name	MEIER										
4	Product	FLEISCH										
5	Weight	1										
6	Recipe	Meat small pieces										
7												
8	DatePhase	Air probe(°C)	Core probe 1(°C)	Core probe 2(°C)	Alarms							
9	16/06/2021	08:55:12	12	Not used	N/A							
10	16/06/2021	08:56:12	2-340	N/A								
11	16/06/2021	08:57:12	2-934	N/A								
12	16/06/2021	08:58:12	3-1128	N/A								
13	16/06/2021	08:59:12	3-1022	N/A								
14	16/06/2021	09:00:11	4-616	N/A								
15	16/06/2021	09:01:11	4-510	N/A								
16	16/06/2021	09:02:11	5-14	N/A								
17	16/06/2021	09:02:21	603	N/A								
18												
19												
20												

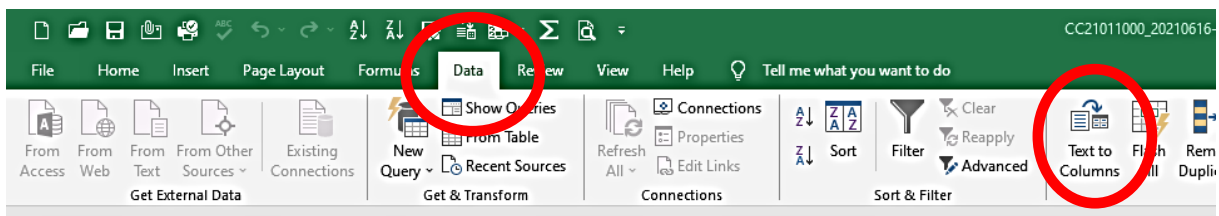

- In the submenu of this function, all further default informations are then already included. Then, please select "Finish".

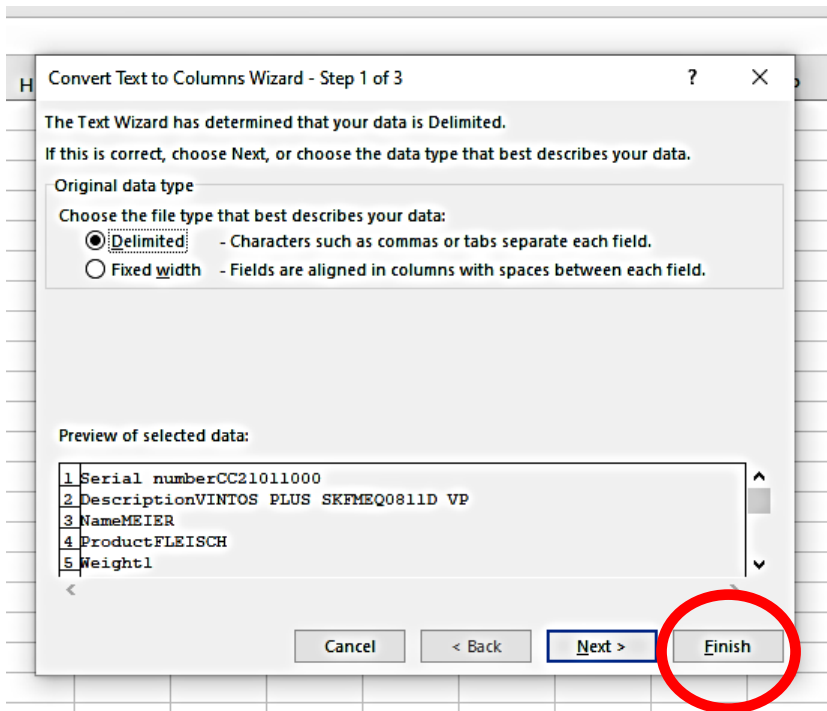

- The HACCP data is then displayed in an Excel list with the following information:
  - serial number of the unit
  - model type
  - author
  - product
  - weight
  - recipe
  - date
  - time
  - air temperature
  - core temperature

	A	B	C	D	E	F	G	H	I	J
1	Serial number	CC21011000								
2	Description	VINTOS PLUS SKFMEQ0811D VP								
3	Name	MEIER								
4	Product	FLEISCH								
5	Weight	1								
6	Recipe	Meat small pieces								
7										
8	Date	Phase	Air probe(°C)	Core probe 1(°C)	Core probe 2(°C)	Alarms				
9	16.06.2021 08:55	1	2	Not used	N/A					
10	16.06.2021 08:56	2	-3	40	N/A					
11	16.06.2021 08:57	2	-9	34	N/A					
12	16.06.2021 08:58	3	-11	28	N/A					
13	16.06.2021 08:59	3	-10	22	N/A					
14	16.06.2021 09:00	4	-6	16	N/A					
15	16.06.2021 09:01	4	-5	10	N/A					
16	16.06.2021 09:02	5	-1	4	N/A					
17	16.06.2021 09:02	6	0	3	N/A					
18										
19										

## 8. MAINTENANCE

Please read the instructions in this section carefully. They contain basic rules for the maintenance of the blast chiller.

### 8.1. SAFETY

For carrying out the cleaning, please note the instructions already given in point 3 and in particular the following safety instructions:

- For general maintenance, do not remove or tamper with safety and protective devices and covers.
- Do not operate with wet hands or feet.
- Do not insert any kitchen utensils or kitchen tools into the protective covers for electrical or mechanical parts.
- Use appropriate and compatible tools for maintenance.
- Disconnect the device from the power supply before carrying out any cleaning work.
- Do not pull on the cable to disconnect the device from the power grid.
- Do not pull on the cable of the core temperature probe in order to pull it out of the product.
- Do not heat the core temperature probe with a flame.

The products are manufactured with extreme care to guarantee customers the highest possible safety standards.

### 8.2. CLEANING

Before cleaning, detach the unit from the power grid.

- Use a damp cloth and a non-abrasive neutral cleaner to clean the steel surfaces on the inside and outside. Wipe thoroughly with a damp cloth (do not rinse clear with a water jet) and dry carefully.
- Do not scrape the surfaces with pointed objects.
- Do not use decomposing substances, solvents, steel pads or brushes, as deposits could damage the machine and interfere with machine operation.
- Use compressed air or a brush with long hair for cleaning (condenser and evaporator).
- Do not use any metal objects, tips, blades or other objects that could cause damage.

### 8.3. CARE

For a permanent preservation of the quality of the unit, the following precautions should be taken.

- Handle the core temperature sensor with care, as the sensor is very sensitive.
- If the unit is not used for a long period of time, apply a protective film with a cloth soaked in Vaseline oil.
- Clean and dry the interior during times when the unit is not in use. Leave the door ajar to promote air circulation.

The power supply should be disconnected if the unit is not used for longer periods of time.

## 8.4. EXTRAORDINARY MAINTENANCE

Any extraordinary maintenance may only be carried out by qualified personnel or by a technician or installer.

The manufacturer denies any responsibility for work that has been performed on the device where the instructions in this operating manual have been disregarded.

## 9. WARRANTY AND CUSTOMER SERVICE

We guarantee that the blast chillers / blast freezers are manufactured with the best materials and the most modern production processes. At the end of the production cycle all units are subject to strict controls by qualified personnel.

All materials used for manufacturing are suitable for use and contact with food.

The refrigerants used in the refrigeration circuit comply with those provided by the regulations in force.

Should you require customer service, please contact the dealer from whom you have purchased the unit, specify precisely the reason for your claim and provide the unit's data indicated on the rating plate on the back of the machine (see point 4: Technical characteristics).

## 10. DISPOSAL AND RECYCLING



The following materials were used in the construction of the blast chiller / blast freezer:

Stainless steel Inox AISI 304 (1.4301)

Copper (cooling circuit)

Refrigerant (R 452A) (cooling circuit)

Compressor oil (cooling circuit)

PVC for food (plastic parts)

Polyurethane (insulation)

Disposal of the machine must be carried out in compliance with the regulations in force in the country of installation. For the recycling of some materials such as refrigerant, insulation material and compressor lubricating oil, you should contact a specialized company.

Technical specifications are subject to change without notice.

# 11. WIRING DIAGRAMS

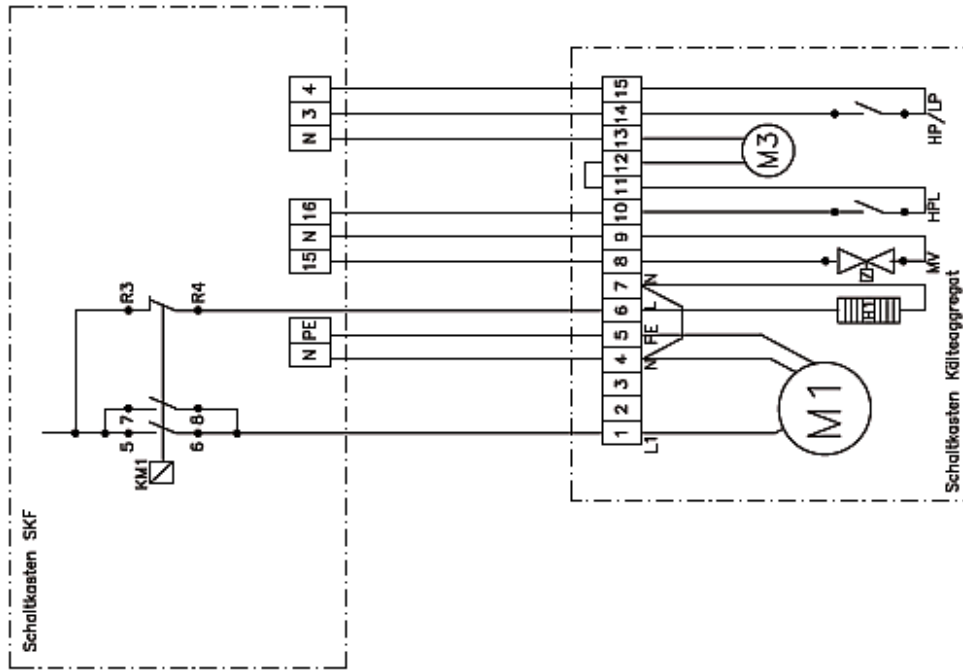

M1	Kältemaschine / refrigeration machine
H1	Übersaug Verdichter / Oil header compressor
MV	Magnetventil / magnetic valve
HPL	Hochdruckschalter Lüfter / High pressure switch fan
M3	Verflüssigerlüfter / Condenser
HP	Hoch - Niederschalter / High-low pressure switch
LP	
TH1	Überstromsicher Kältemaschine / Overcurrent release chiller
KM1	Relais Kältemaschine / Chiller relay

<small>Alle Zeichnungen sind ohne Gewähr zu verstehen, es sei denn, es wird ausdrücklich anders vereinbart.          Alle Maße sind in mm angegeben, es sei denn, es wird ausdrücklich anders vereinbart.</small>		Art-Nr. 05-003-803166	Abmessung BxHxT: 100x100x100	Material Stahl
Zeichnung A2	Datum 08.03.2013	Version 01	Hersteller coel compact	Projekt SKF Vintos/Vintos+ 4 und 8 externe Maschine
coel compact Kälteanlagenbau Tübingen www.coelcompact.de				



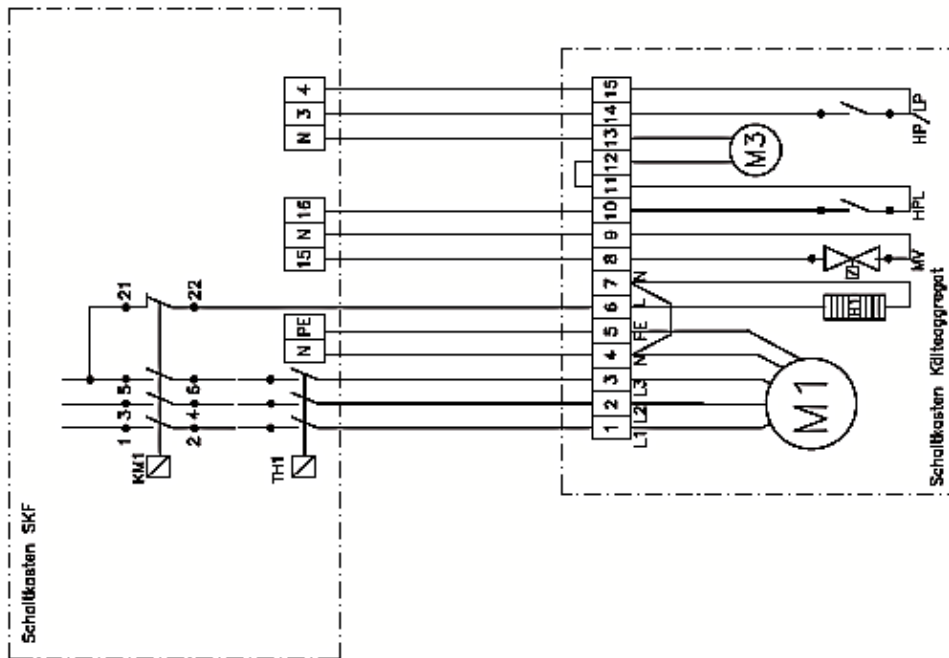

M1	Kältemaschine / refrigeration machine
H1	Überw. Verdichter / OT heater compressor
MV	Magnetventil / magnetic valve
HPL	Hochdruckschalter Lüfter / High pressure switch fan
M3	Ventilabgebläse / Condenser
HP	Hoch - Niedruckschalter / High-low pressure switch
LP	Unterniedruckschalter / Low-low pressure switch
TH1	Überstromsicherer Kältemaschine / Overcurrent release chiller
MM1	Relais Kältemaschine / Chiller relay

<small>Das Gehäuse ist nicht zu öffnen, wenn die Maschine in Betrieb ist!</small>		Art.-Nr. 05-03-802935	Aufzeichnung Bauteilbes.-L/B "CC" Leitungsp. SKF Vintoss/Vintoss-IP und B externe Maschine	Werkstoff 10 und B externe Maschine
Hersteller A2	Bauteilnummer 05-03-802935	Menge 1	Zeichnung 05-03-802935	Material 10 und B externe Maschine
<small>KONTAKT- UND VERBUNDENHEITEN TÜBEN OBERFLÄCHE REINHALTEN</small>				
Dat.	Ausgabe	Druck	Blatt	von

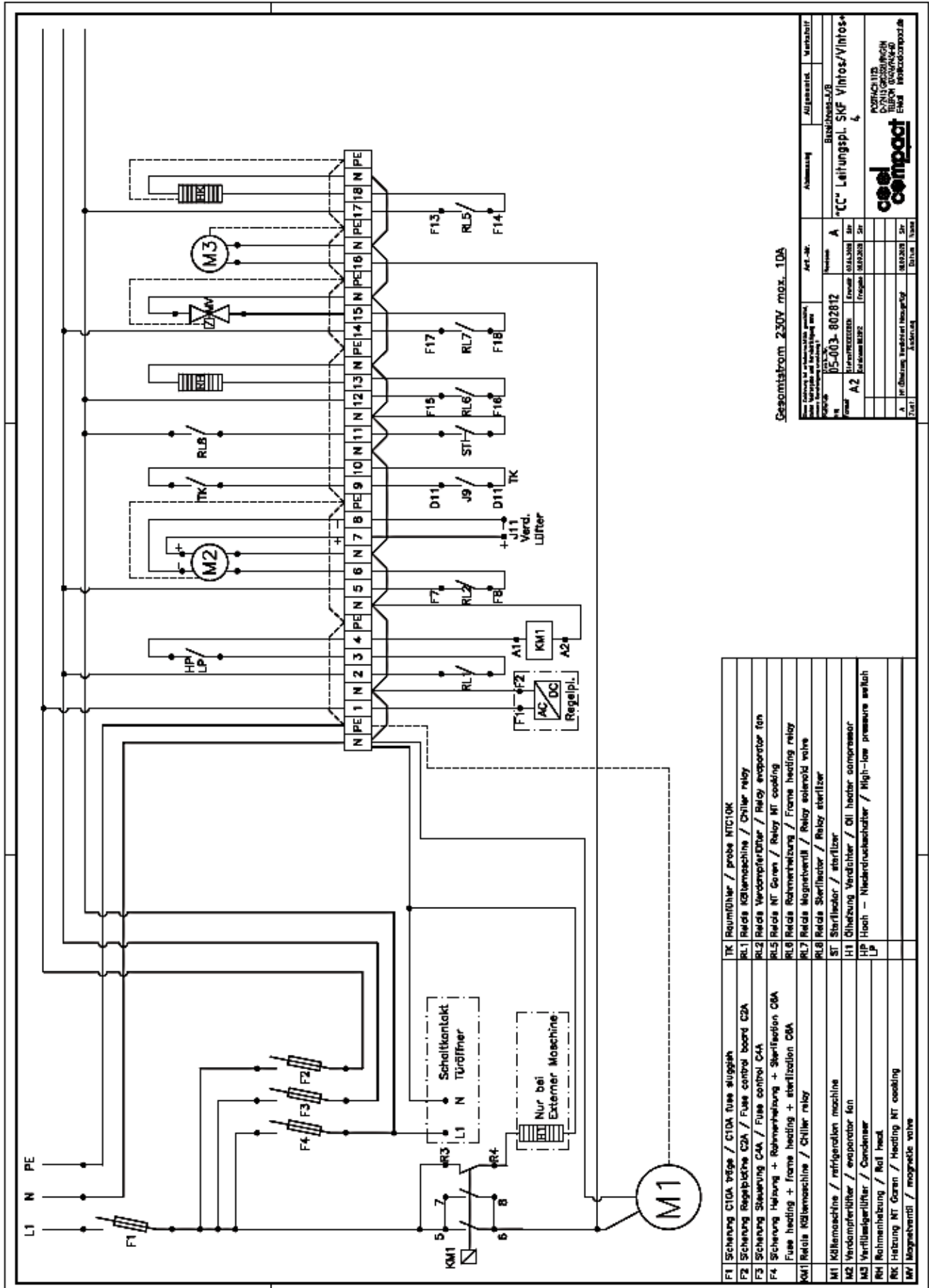

Gesamtabstrom 230V max. 10A

Best.-Nr.	Abmessung	Material	Verpackung
05-003-802812	A	Bauhöhe-LB	
Art.-Nr.	"CC" Leitungspl. SNF Vintros/Vintros+		
Art.-Nr.	4		
Art.-Nr.	6		
Art.-Nr.	8		
Art.-Nr.	10		
Art.-Nr.	12		
Art.-Nr.	14		
Art.-Nr.	16		
Art.-Nr.	18		
Art.-Nr.	20		
Art.-Nr.	22		
Art.-Nr.	24		
Art.-Nr.	26		
Art.-Nr.	28		
Art.-Nr.	30		
Art.-Nr.	32		
Art.-Nr.	34		
Art.-Nr.	36		
Art.-Nr.	38		
Art.-Nr.	40		
Art.-Nr.	42		
Art.-Nr.	44		
Art.-Nr.	46		
Art.-Nr.	48		
Art.-Nr.	50		
Art.-Nr.	52		
Art.-Nr.	54		
Art.-Nr.	56		
Art.-Nr.	58		
Art.-Nr.	60		
Art.-Nr.	62		
Art.-Nr.	64		
Art.-Nr.	66		
Art.-Nr.	68		
Art.-Nr.	70		
Art.-Nr.	72		
Art.-Nr.	74		
Art.-Nr.	76		
Art.-Nr.	78		
Art.-Nr.	80		
Art.-Nr.	82		
Art.-Nr.	84		
Art.-Nr.	86		
Art.-Nr.	88		
Art.-Nr.	90		
Art.-Nr.	92		
Art.-Nr.	94		
Art.-Nr.	96		
Art.-Nr.	98		
Art.-Nr.	100		

TK	Reiniger / probe RTCOR
RL1	Relais Kältemaschine / Chiller relay
RL2	Relais Verdampferlüfter / Relay evaporator fan
RL5	Relais HT Garen / Relay HT cooking
RL6	Relais Rahmenheizung / Frame heating relay
RL7	Relais Magnetenklapp / Relay solenoid valve
RL8	Relais Sterilfaktor / Relay sterilizer
ST	Sterilfaktor / sterilizer
H1	Heizung Verdampfer / Oil heater compressor
HP	Hoch - Niederdruckschalter / High-low pressure switch
LP	
M1	Kältemaschine / refrigeration machine
M2	Verdampferlüfter / evaporator fan
M3	Verfrühlgelüfter / Condenser
RI	Reiniger / Rel head
RI	Heizung HT Garen / Heating HT cooking
RI	Magnetenklapp / magnetic valve



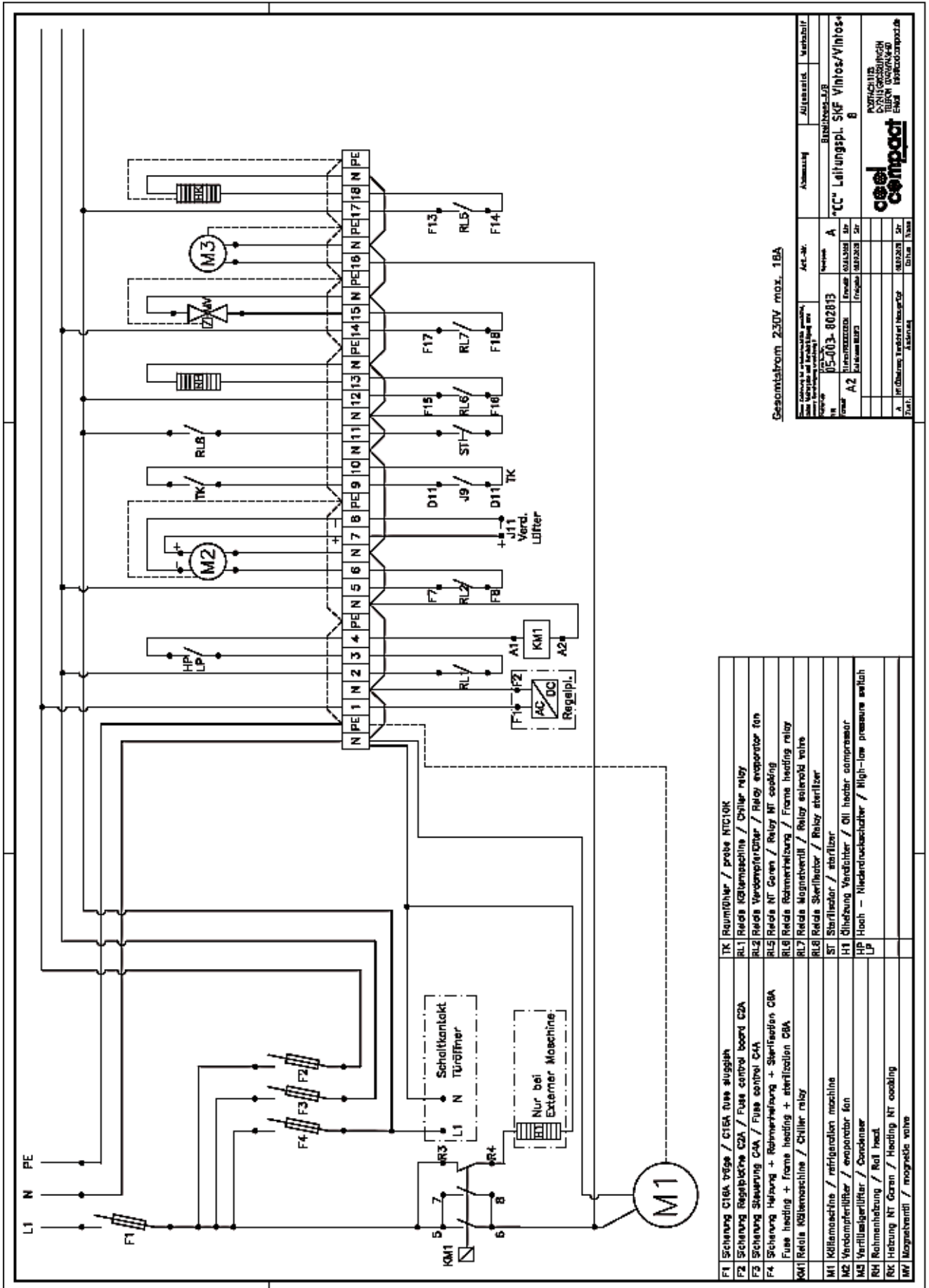

Gesamtstrom 2,30V max. 18A



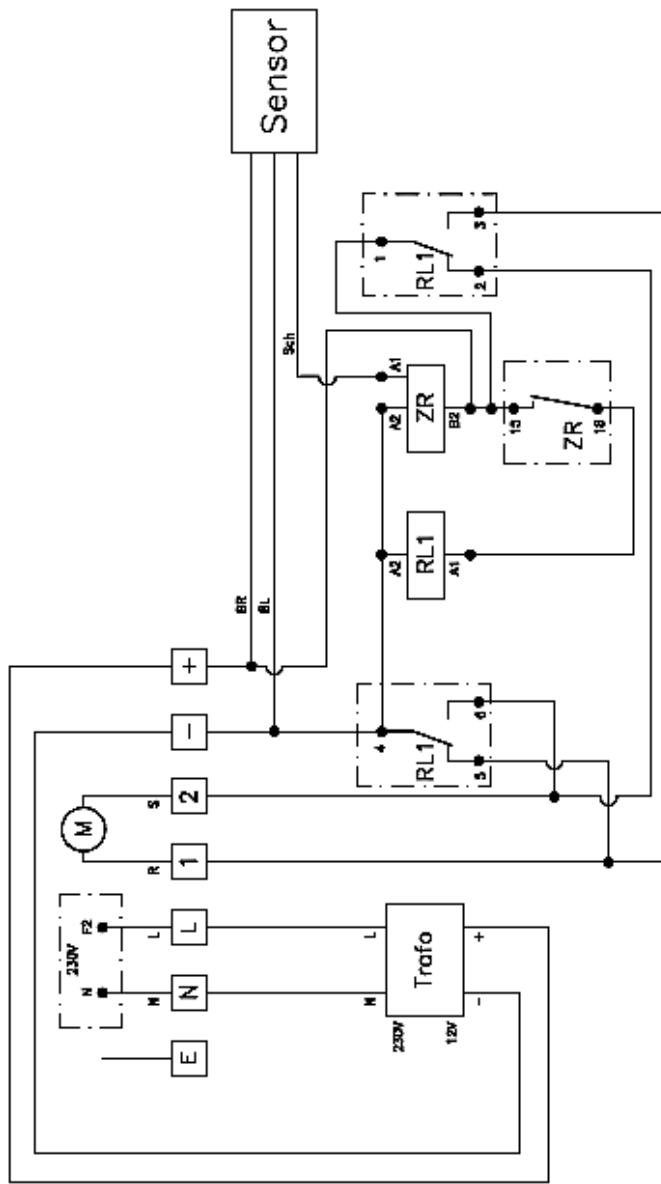

Diese Zeichnung ist urheberrechtlich geschützt, daher Nachzusage und Vervielfältigung ohne unsere Genehmigung verboten!		Art.-Nr.		Abmessung		Allgemeinheit.		Werkstoff	
Hauptstab		Zeich.-Nr.		Revision		Bezeichnung-A/B			
1:0		05-003-802688							
Format		Erstautor/REDAZ/DEHN		Erststart		15.02.2018		Str	
A3		Carl/haas/802688		Preisgabe		14.02.2009		Str	
Zust.		Änderung		Datum		Name			

Leitungsplan Steuerung Türöffner für Vintros +

cool compact

POSTFACH 1123  
D-72415 GROßSIEBINGEN  
TELEFON 0714749454-0  
E-Mail: info@coolcompact.de

M	Motor Türöffner / Motor door opener
S	Sensor / sensor
RL1	Relais 1 / Relay 1
ZR	Zeitrelais / time Relays
T	Trafo 12V DC / Transformier 12V DC





## 12. EU DECLARATION OF CONFORMITY

We herewith declare that, in accordance with the EC Machinery Directive 2006/42/EC (MD), EMV 2014/30/EU and Low Voltage Directive 2014/35/EU, the devices named below, due to their design, comply with the relevant safety and health requirements of the EC Directive.

### Designation / Data

The product described above is compliant with the requirements of the following documents:

EN 55014-1:2018-02	Electromagnetic compatibility part 1
EN 55014-2:2016-01	Electromagnetic compatibility part 2
EN 61000-3-2:2019-12	Electromagnetic compatibility part 3
EN 61000-3-3:2020-07	Electromagnetic compatibility part 3-3 (EMV)
EN 60335-1:2020-08	Safety of electrical appliances and machines for household and similar electrical appliances.
EN 60335-2-34:2014-10	Safety of electrical appliances and machines for household and similar electrical appliances. Particular requirements for motor compressors.
EN 378-1:2018-04	Refrigerating systems and heat pumps. Safety and environmental requirements.
EN 62233:2009-04	Measurement methods for electromagnetic fields of household appliances and similar electrical appliances.
EN IEC 63000:2019-05	Technical documentation for the evaluation of electrical and electronic products in relation to the restriction of hazardous substances.
DIN 18872-5-2013-04	Blast chiller and blast freezer. Requirements and testing.

If any unauthorized changes are made to the units, this declaration shall lose its validity.

As of:08/2020

**Cool Compact Kühlgeräte GmbH**

EN 220 305.online/135.02.2022 / Kö/BR